

A low mutual coupling four-port MIMO antenna for WiMAX, Bluetooth and WLAN

Yashar Zehforoosh¹ , Mahdi Jalali^{1,2,*} 

¹Microwave and Antenna Research Center, Islamic Azad University, Urmia Branch, Urmia, Iran.

²Department of Electrical Engineering, Islamic Azad University, Naghadeh Branch, Naghadeh, Iran.

*Corresponding author: mahdi.jalali@iau.ac.ir

Original Research

Abstract:

Received:
8 January 2024
Revised:
24 February 2024
Accepted:
27 March 2024
Published online:
11 May 2024

© The Author(s) 2024

This study presents a four-element compact Multi-Input Multi-Output antenna with enhanced isolation for applications with three bands. The four-port antenna elements have hook-shape multiband monopole elements with 50 Ω microstrip feed lines and are placed such that they are perpendicular to one another to enhance the act of the MIMO system. Simulation and measurement consequences demonstrate that the antenna operates at a consistent gain and radiation patterns at the major frequency bands of 2.11 – 2.47 GHz, 3.14 – 3.54 GHz, and 5.15 – 5.85 GHz with $S_{11} < -10$ dB. To verify the claimed MIMO antenna performance, data in the format of radiation patterns, peak gain (4.9, 5.2, 5.8 dB), diversity gain (DG) (9.95, 9.92, 9.92 dB), envelope correlation coefficient (ECC) (0.005, 0.003, 0.002), TRAC, channel capacity and MEG ratio are retrieved. These specifications of the suggested antenna make it a suitable candidate for WiMAX, Bluetooth, and WLAN uses. Additionally, the suggested antenna outperformed current work by providing a superior balance of size, bandwidth, and several performance characteristics.

Keywords: MIMO; Minimal mutual coupling; Bluetooth; WiMAX; TARC; MEG

1. Introduction

MIMO¹ antennas are used in wireless networks, on their features and benefits, for instance as reduced multiple fading, increased capacity, maximum DTR², minimum bit error rate, and ease of implementation [1–5]. A crucial component of 3G, 4G, 5G, and upcoming 6G wireless data communications is MIMO technology [6]. In order to reach a high capacity of the channel, the antenna elements must have a maximum gain and a large lobe [7]. Increasing the isolation among components affects diversity gain, capacity, and reliability. To improve the isolation among the components in the MIMO antenna, some methods are researched. Different forms of stubs are utilized to refine the isolation among ports as described in [8–14]. In [15–20], the isolation can be improved by arranging the antenna elements crosswise formation.

In References [21–23], a number of triple-band MIMO antennas are listed. It is demonstrated in [21] that vari-

ous MIMO arrays offer good envelope correlation, high peak gain, and fine scattering features across triple-band. however, it is incapable of accommodating the 3.5 GHz frequency band of WiMAX. To provide appropriate S -parameters in [22], the MIMO antenna must be utilized in a perpendicular structure.

Additionally, a planar tri-band array antenna on the 2.4, 5.2, and 5.8 GHz bands is presented in [23]. Ref. [24] presents a 2.4 GHz MIMO antenna in wireless LANs that has two series of radiation patches and slots in the ground plane. A double-band antenna for WLAN (2.4 GHz) and UMTS (2.0 GHz) with a diversity feature is shown in [25].

Designing a new wireless telecommunication network requires a multi-band antenna that can cover WLAN, WiMAX, and Bluetooth applications. Various investigations have centered on the design of array antennas that work on wireless LAN and WiMAX systems. Ref. [26] provides a four hook-shaped rings monopole antenna that covers three bands (GSM 1800/1900 MHz, Bluetooth 2400 MHz, wireless LAN 2400/5200 MHz, and WiMAX 2500/3500/5500 MHz). Ref. [27] illustrates a UWB CPW Planner antenna

¹Multiple-Input Multiple-Output

²data transfer rate

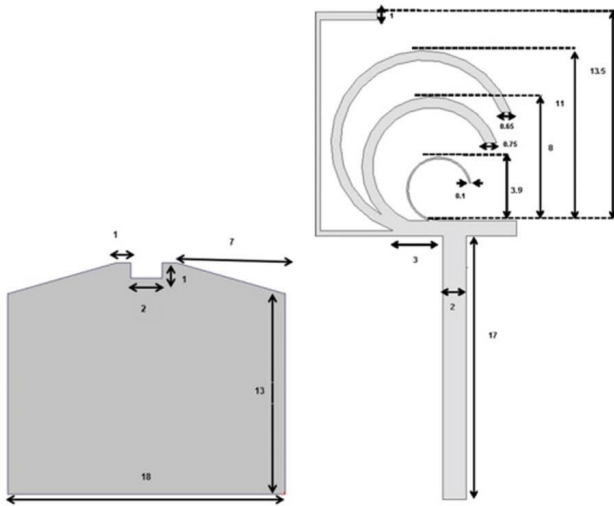

Figure 1. Configuration and dimension of the proposed antenna (mm) [26].

for any portable wireless communication device. In [28], a tiny hand-shaped monopole antenna for five important bands (2400, 3300, 3700, 5200, 5800 MHz) is presented. Hence, this work aims to design a compact tri-band array for 2.11 – 2.47 GHz, 3.14 – 3.54 GHz, and 5.15 – 5.85 GHz. Section 2 reviews the single antenna configuration [26]. A reformatted plane in the ground of the antenna also causes matching in impedance. A thin microstrip line is applied to feed the radiating element. The operation of the MIMO antenna system’s unit element and the mutual coupling reduction technique are described in section 3 of the manual. Furthermore, the performance of the proposed geometry is compared with measures like gain, reflection coefficient (*S*-parameter), radiation pattern, bandwidth, diversity gain envelops correlation coefficient, and some other MIMO features such as channel capacity, MEG ratio, and TARC. The experimental demonstration proved that the designed antenna is miniaturized and useful for wireless applications. Simulations are done with Ansys Electronics Desktop 2020(r2). In section 4, the manuscript is concluded.

2. Single antenna configuration

The designed single-element antenna with its actual dimensions is reviewed in Fig. 1. Figure 2 shows the effect of

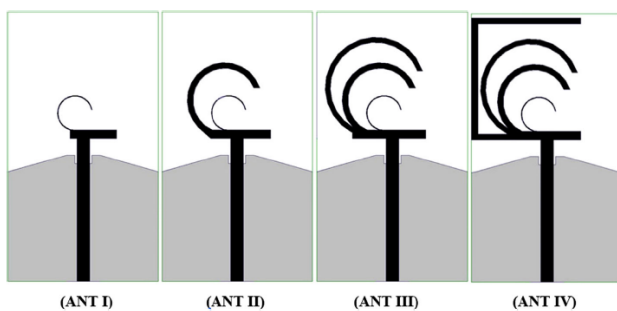

Figure 2. The effect of increasing the number of resonators in hook-shaped antenna [26].

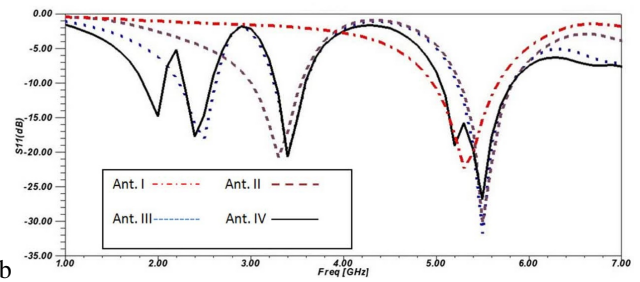

Figure 3. Simulated *S*11 for antennas introduced in Fig. 2 [26].

adding hook shape elements to the radiating patch. Fig. 3 depicts the *S*11 characteristics for the four antennas mentioned in Fig. 2. The contrast of *S*11 specifications is demonstrated as the number of frequency resonances increases. The number of resonances increases through adding hooks to the radiating patch. Final proposed multiband configuration is built on an FR4 epoxy material and has a relative permittivity of 4.4 and a loss tangent of 0.022. Furthermore, Fig. 4 depicts the simulation and measured *S*11 plot. The antenna’s simulated *S*11 is tremendously similar to the measured outcome [26].

3. Proposed 4 ports antenna

Without adding additional radiation power or spectrum bandwidth, increasing the number of transceiver elements can refine the wireless communication level and improve the channel capacity. This section displays a 52 mm × 52 mm × 1.6 mm substrate with four hook-shaped symmetric components on the upper and 4 symmetric truncated ground planes engraved on the down. Each element of the proposed 4-ports MIMO antenna is loaded with 50 Ohm as shown in Fig. 5. Fig. 6 shows the isolation level between two elements of the proposed antenna with different distances *d* using the parametric analysis method. As can be seen from the figure, the best distance is 10.65 mm. When the distance between two elements decreases, the mutual promotion increases, and increasing the distance leads to the enlargement of the dimensions of the antenna structure. To approve the simulation results, the suggested MIMO antenna has been built and analyzed with the help of the KEYSIGHT-PNA-XN5242A Network Analyzer, the constructed antenna is measured (Fig. 7). Because of the

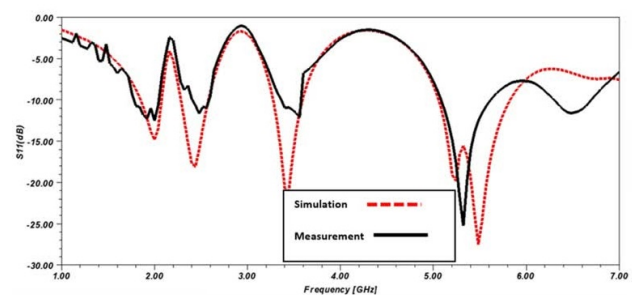

Figure 4. *S*-parameter of the proposed configuration in Ref. [26].

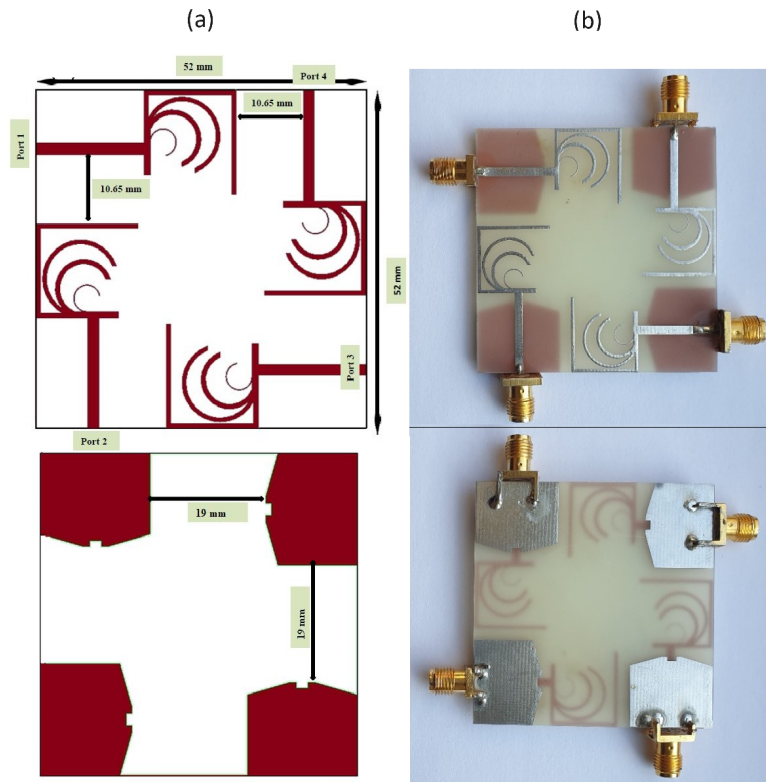

Figure 5. Configuration of the suggested 4 ports UWB antenna (a) 2-D configuration (b) fabricated prototype photo.

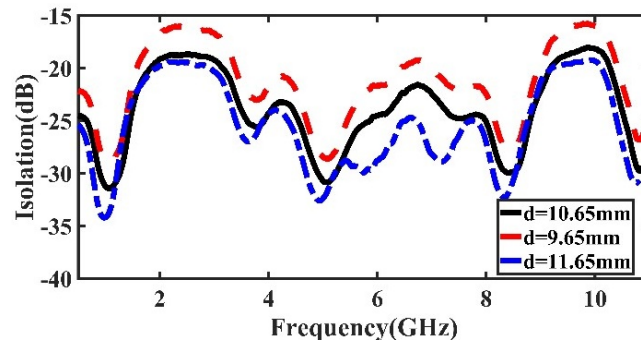

Figure 6. Isolation levels of 2-element MIMO antenna with parametric analysis.

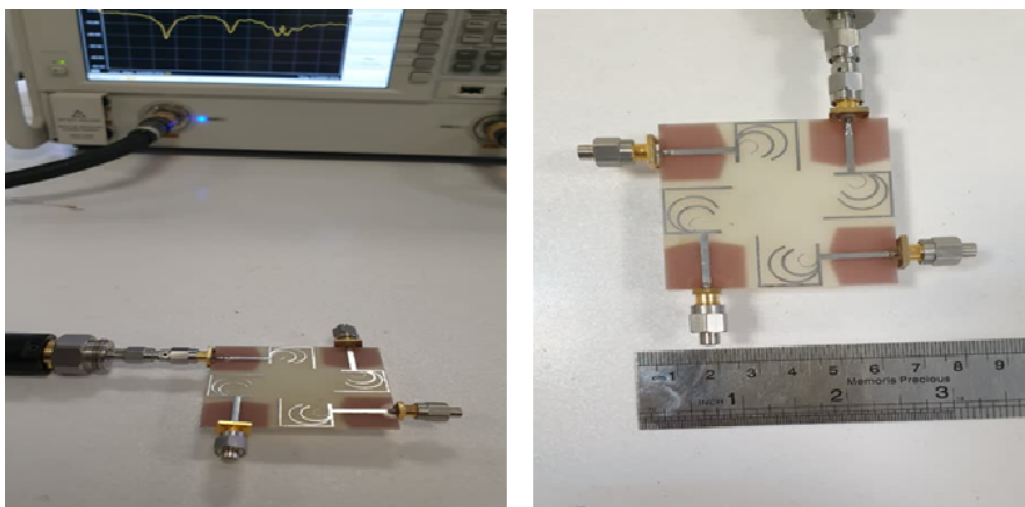

Figure 7. Photograph of the manufactured MIMO antenna.

symmetry property, port 1 is where the measured results are extracted, and the results from the other three ports are identical.

Fig. 8 displays the simulation and measurement results for the suggested MIMO antenna in port one. The experimental findings reveal that this project operates in three bands between 2.11 and 2.47 GHz, 3.14 and 3.54 GHz, and 5.15 and 5.85 GHz. With a slight shift brought on by the fabrication process, the two results follow the same general trend. Fig. 9 displays the results of the simulation and measurement of the insertion loss at port 1 (S_{21} , S_{31} , and S_{41}). The antenna offers a least isolation of 21, 32, and 21 dB while a peak isolation of 32, 45, and 34 dB in 2.11 and 2.47 GHz,

3.14 and 3.54 GHz, and 5.15 and 5.85 GHz, respectively. Additionally, as shown in Fig. 8, the results match with one another despite the slight shift.

Fig. 10 displays the simulated current distributions for port one of the suggested MIMO antenna at 2200 MHz, 3300 MHz, and 5400 MHz. The antenna radiates at these three frequency bands because the current is concentrated around the patch. Additionally, the current is centralized near the antenna, and just a tiny some of the current can flow through to other ports, confirming the maximum level of port isolation.

In an anechoic chamber, the suggested MIMO antenna radiation patterns and peak gain are measured. Port 1 is used

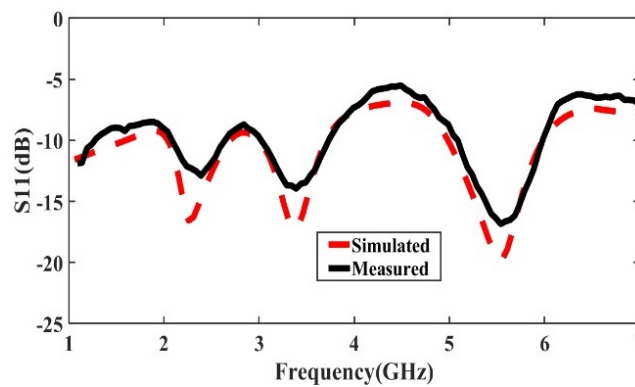

Figure 8. Simulated and measured S_{11} results of the suggested 4-ports MIMO antenna at port 1.

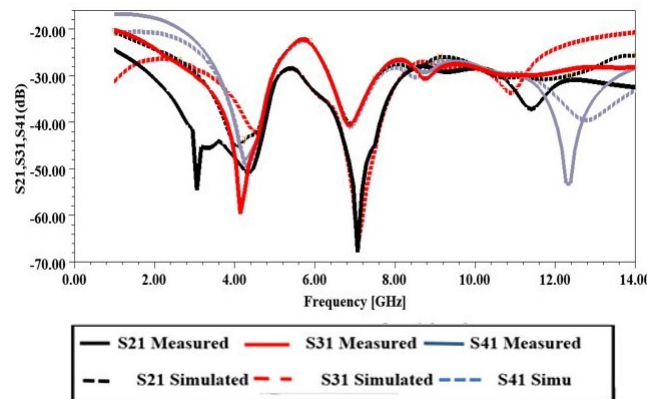

Figure 9. Simulated and measured S_{21} results of the suggested 4 ports UWB antenna at port 1.

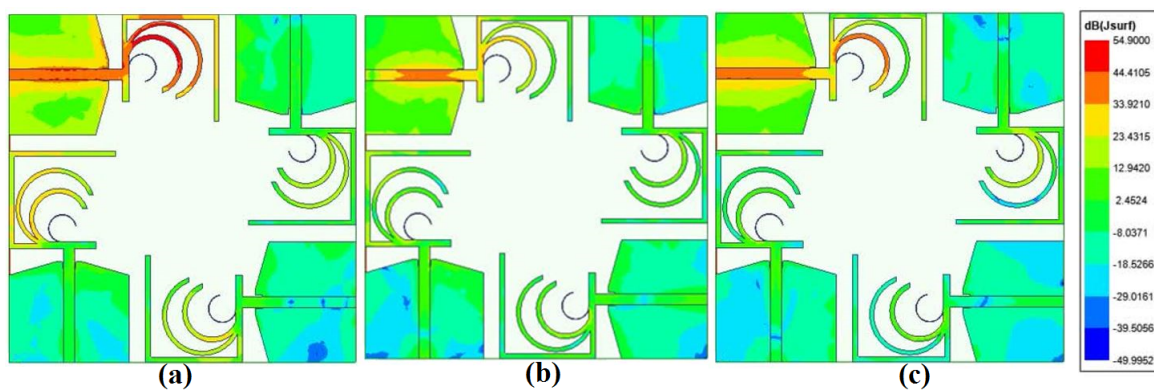

Figure 10. Simulated results of current distributions of the suggested antenna for port 1 (a) @ 2200 MHz (b) @ 3300 MHz (c) @ 5400 MHz.

to measure the antenna, and 50 loads are connected to the other three ports. Fig. 11 displays the normalized radiation patterns at the x-z and y-z planes at 2.2 GHz, 3.3 GHz, and 5.4 GHz. The antenna's omnidirectional pattern in the x-z plane and semi-bidirectional pattern in the y-z plane can be seen. The antenna, however, has omnidirectional patterns in both planes at the maximum frequency band and low cross-polarization level are achieved (-25 dB). The results, both simulated and measured, also follow the same pattern. The gain and efficiency of the proposed antenna for 1 to 7 GHz is shown in Fig. 12. It demonstrates that the gain is nearly 5.5 dB and is flat across frequency bands. Additionally, Fig. 12 illustrates antenna efficiency that over the three operating bands is about 90%, confirming the antenna's strong performance.

Several parameters should be provided that verify the efficacy of the suggested antenna for MIMO applications. The ECC³, DG⁴, TARC⁵, channel capacity, and MEG⁶ are some factors that are used to evaluate MIMO performance. ECC should be zero, and DG must be smaller than 10 dB. The following relationship is used to compute the ECC and DG values for any MIMO system in terms of scattering

parameters [8].

$$ECC = \frac{|S_{11}^* S_{21} + S_{12}^* S_{22}|^2}{(1 - |S_{11}|^2 - |S_{21}|^2)(1 - |S_{22}|^2 - |S_{12}|^2)} \quad (1)$$

$$DG = 10 \times \sqrt{1 - (ECC)^2} \quad (2)$$

The ECC at the targeted band must be smaller than 0.02 which is sufficient for MIMO systems. The DG is depicted in Fig. 13. Its value throughout the entire frequency range is approximately 9.95 dB. Additionally, the suggested antenna has well MIMO performance, which qualifies it for MIMO diversity systems.

The total active reflection coefficient is mainly used to characterize a system with multiple antennas, and it is defined in terms of S-parameters as:

$$TARC = \sqrt{\frac{(S_{mm} + S_{mn})^2 + (S_{nm} + S_{nn})^2}{2}} \quad (3)$$

To use a MIMO system for an application, TARC should be lower than 0 dB [29]. Here, the TARC plots for MIMO antenna at the operating frequencies (Fig. 14). This implies that all the antennas in MIMO have good return loss when excited at the same time.

Mean effective gain (MEG) is an important metric that validates the performance of individual antennas of the MIMO system. It is defined as the ratio of power received by MIMO array antennas and the power received by isotropic

³Envelop Correlation Coefficient
⁴Diversity Gain
⁵Total Active Reflection Coefficient
⁶Mean Effective Gain

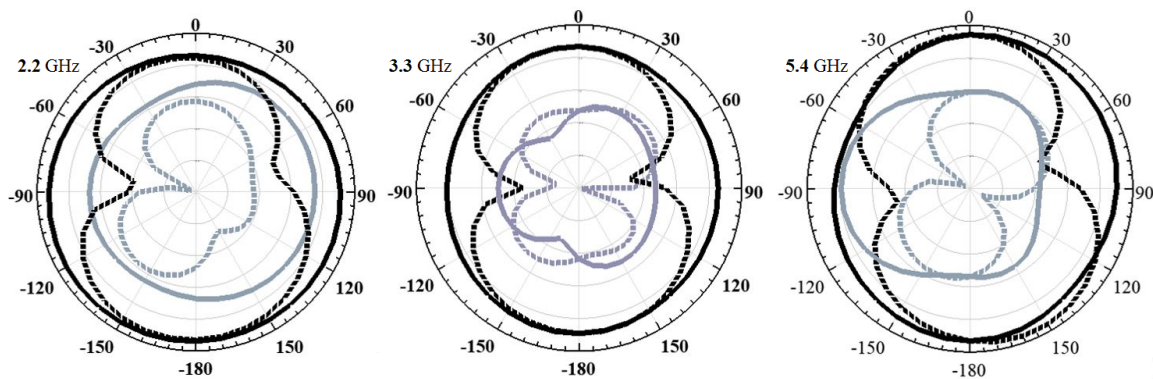

Figure 11. Radiation pattern measurements of the introduced 4 ports MIMO antenna in port 1.

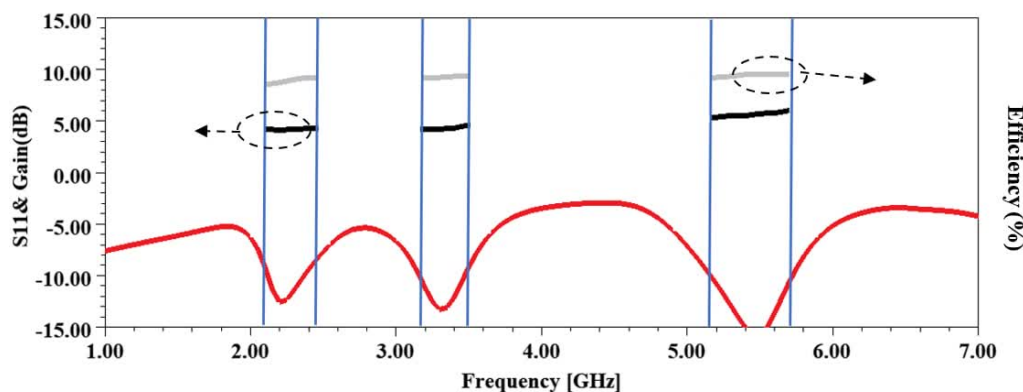

Figure 12. The gain and efficiency plots of the proposed MIMO antenna.

Table 1. Comparison between our suggested work and other selected designs.

Ref.	Isolation techniques	Size(mm ³)	Operating bands (GHz)	Peak gain (dBi)	Diversity gain (dBi)	ECC	Min isolation (dB)	C
[8]	defecting the network microstrip line	85×73×0.8	4-8	9.9	9.8	0.00061	23	33
[9]	Multi-layered decoupling structure	160×160×13	2.4-2.48 4.905-5.845	5.07 6.5	No. info.	0.02 0.007	17 30	30 45
[10]	Slotted ground plane	104×104×0.51	2.39-2.81 5-5.6	3.8 6.2	No. info.	0.001 0.002	22 24	28 39
[11]	Shorted ground with SRR.	32×20×0.8	3.3-7.75 7.9-12	3.2 4.6	9.91 9.95	0.01 0.01	20 20	27 35
[12]	Slotted ground with metallic strips	50×70×1.6	2.21-3.13 3.4-3.92 5.62-5.86	1.5 4.2 2.3	9.997 9.997 9.999	0.001 0.001 0.003	22 26 28	33 36 36
[13]	Physical spacing between elements	45×90×13	0.89-0.93 1.73-2.09 2.3-2.4	1.3 3.7 0.2	9.995 9.995 9.995	0.0005 0.0003 0.006	12.2 17.8 25	15.3 33 31
[14]	Separated ground plane	25×70×1.6	2.3-2.52 3.4-3.62 5.6-5.95	1.98 3.1 1.6	No. Info.	0.002 0.002 0.001	24 22 25	30 26 28
This work	truncated ground plane	52×52×0.8	2.1-2.4 3.1-3.5 5.1-5.8	4.9 5.2 5.8	9.95 9.92 9.92	0.005 0.003 0.002	22 31 22	32 45 34

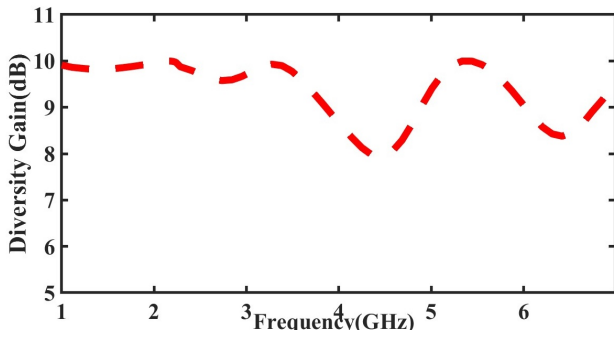

Figure 13. DG results of the suggested antenna.

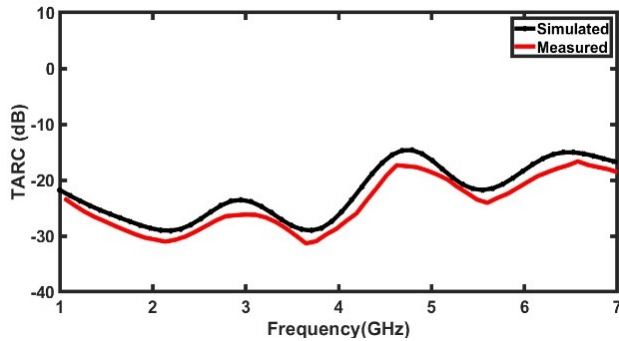

Figure 14. Simulated and measured TARC vs. frequency.

antenna. For optimal performance of a MIMO system, the ratio of MEG_i/MEG_j for antenna i and j , should not exceed 0.3 dB [30]. Mean effective gain for MIMO can be calculated using Equations (4) and (5) [30]:

$$MEG_i = 0.5[1 - |S_{ii}|^2 - |S_{ij}|^2] \tag{4}$$

$$MEG_j = 0.5[1 - |S_{ij}|^2 - |S_{jj}|^2] \tag{5}$$

The mean effective gain ratio for antenna pair (i, j) given by MEG_i/MEG_j (in dB) is estimated over the frequency range from 1 – 7 GHz as shown in Fig. 15 where the environment for outdoor propagation is considered as uniform [30].

An important metric to assess a MIMO system is the channel capacity. It is mathematically expressed as [9]:

$$CC = E\{\log_2[\det(1 + SNR/n)H_{scale}H_{scale}^T]\} \tag{6}$$

where E is the expectation function, SNR is the signal-to-noise ratio and H_{scale} is the channel matrix determined from the radiation pattern of the antenna array. The MIMO system’s total efficiency should be considered for the channel capacity calculation of the MIMO antenna. Fig. 16 shows the channel capacity for the MIMO system, which was obtained and plotted using MATLAB programming. Table 1 compares our suggested MIMO antenna with related research for similar applications released in the written works. The systems reported in [9–11] have low isolation between the MIMO elements and are dual-band. The antennas described in [8] on the other hand, offer a whole band of C . The plans in [12–14] give contrast triple-band specifications, along with accurate diversity and gain function. These systems are large, though. With its small size, low ECC, intermediate gain, and least isolation of > 20 dB, our

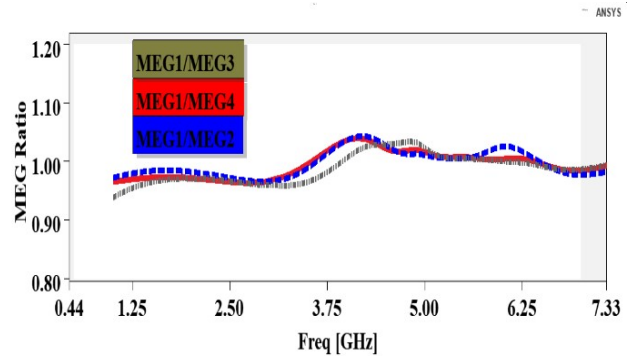

Figure 15. MEG ratio for 4 elements MIMO antenna.

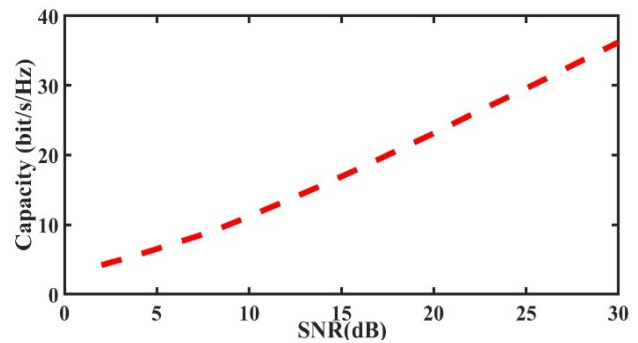

Figure 16. Channel capacity for 4 elements MIMO antenna.

plan has better performance among antennas in Table 1. It could therefore be used for compact-size electronics.

4. Conclusion

In this research, a four-port MIMO antenna has been studied. The suggested antenna element is first constructed and tested as an initial design. Following that, a four-port MIMO antenna with a perpendicular configuration was discussed, modeled, made, and tested using a VNA. Additionally, research has been done on radiation patterns, peak gain, and MIMO performance metrics. The suggested antenna has been tested with more than 32, 45, 34 dB, port isolation, and 4.9, 5.2, 5.8 dB peak gain in the tri-band range of 2.11 – 2.47, 3.14 – 3.53, and 5.15 – 5.85 GHz. Additionally, the suggested antenna outperformed the relevant design by providing a well equivalent of size, bandwidth, and different performance parameters when compared to state-of-the-art work.

Authors Contributions

All authors have contributed equally to prepare the paper.

Availability of Data and Materials

The data that support the findings of this study are available from the corresponding author upon reasonable request.

Conflict of Interests

The authors declare that they have no known competing financial interests or personal relationships that could have appeared to influence the work reported in this paper.

Open Access

This article is licensed under a Creative Commons Attribution 4.0 International License, which permits use, sharing, adaptation, distribution and reproduction in any medium or format, as long as you give appropriate credit to the original author(s) and the source, provide a link to the Creative Commons license, and indicate if changes were made. The images or other third party material in this article are included in the article's Creative Commons license, unless indicated otherwise in a credit line to the material. If material is not included in the article's Creative Commons license and your intended use is not permitted by statutory regulation or exceeds the permitted use, you will need to obtain permission directly from the OICC Press publisher. To view a copy of this license, visit <https://creativecommons.org/licenses/by/4.0>.

References

- [1] M. K. A. Nayan, M. F. Jamlos, and M. A. Jamlos. "Circularly Polarized MIMO Antenna Array for Point-To-Point Communication.". *Microwave and Optical Technology Letters*, 57(1), 2015.
- [2] C. Mao and Q. Chu. "Compact Coradiator UWB-MIMO Antenna with Dual Polarization.". *IEEE Transactions on Antennas and Propagation*, 59(5), 2014.
- [3] R. Kh. Mohammad Lou, M.Naser-Moghadasi, and R. A. Sadeghzadeh. "Broadband Planar Aperture-Coupled Antenna Array for WLAN and ITS Beam-Steering Applications.". *Radio Science*, 53(2):pp. 200–209, 2018.
- [4] S. Shoaib, I. Shoaib, N. Shoaib, X. Chen, and C. G. Parini. "Design and Performance Study of a Dual-Element Multiband Printed Monopole Antenna Array for MIMO Terminals.". *IEEE Antennas and Wireless Propagation Letters*, 13, 2014.
- [5] H. K. Jung, H. H. Jung, and N. H. Myung. "A Broad-band Technique for a Decoupling Network in a Compact Antenna Array in a MIMO System.". *Progress in Electromagnetics Research C*, 52:pp. 27–38, 2014.
- [6] C. Yeh, G. D. Jo, Y. J. Ko, and H. K. Chung. "Perspectives on 6G wireless communications.". *ICT Express*, , 2022.
- [7] R. Khajeh Mohammad Lou and M. Naser-Moghadasi. "Wideband aperture-coupled antenna array based on Fabry–Perot resonator for C-band applications.". *IET Microwaves, Antennas & Propagation*, 11(6):pp. 859–866, 2017.
- [8] M. Jalali, M. Naser-Moghadasi, and R. A. Sadeghzadeh. "Dual circularly polarized multi-layer MIMO antenna array with an enhanced SR-feeding network for C-band application. ". *International Journal of Microwave and Wireless Technologies*, 9(8):pp. 1741–1748, 2017.
- [9] I. Yeom, Y. B. Jung, and C. W. Jung. "Wide and dual-band MIMO antenna with omnidirectional and directional radiation patterns for indoor access points. ". *J. Electromagn. Eng. Sci*, 19:pp. 20–30, 2019.
- [10] M. Ikram, N. Nguyen-Trong, and A. Abbosh. "Multiband MIMO microwave and millimeter antenna system employing dual-function tapered slot structure.". *IEEE Trans. Antennas Propag*, 67:pp. 5705–5710, 2019.
- [11] W. M. Abdulkawi, W. A. Malik, S. U. Rehman, A. F. A. Sheta A. Aziz, and M. A. Alkanhal. "Design of a compact dual-band MIMO antenna system with high-diversity gain performance in both frequency bands.". *Micromachines*, 12:pp. 383, 2011.
- [12] N. K. Sahu, G. Das, and R. K. Gangwar. "Dual polarized triple-band dielectric resonator-based hybrid MIMO antenna for WLAN/WiMAX applications.". *Microw. Opt. Technol. Lett*, 60:pp. 1033–1041, 2018.
- [13] I. K. C. Lin, M. H. Jamaluddin, A. Awang, R. Selvaraju, M. H. Dahri, L. C. Yen, and H. A. Rahim. "A triple band hybrid MIMO rectangular dielectric resonator antenna for LTE applications.". *IEEE Access*, 7:pp. 122900–122913, 2019.
- [14] R. Karimian and H. Tadayon. "Multiband MIMO antenna system with parasitic elements for WLAN and WiMAX application.". *Int. J. Antennas Propag*, :pp. 365719, 2013.
- [15] M. Jalali and T. Sedghi. "Circularly Polarized MIMO Antenna Array with Enhanced Characteristics using EBG structure.". *Electronic Industries*, 10(2):pp. 13–24, 2019. URL <https://sid.ir/paper/229582/en>.
- [16] D. Sibal, M. P. Abegaonkar, and S. K. Koul. "Easily extendable compact planar UWB MIMO antenna array.". *IEEE Antennas and Wireless Propagation Letters*, 16:pp. 2328–2331, 2017.
- [17] S. Kunal, K. Ashwani, K. K. Binod, S. Dwari, and S. Kumar. "A CPW-fed UWB MIMO antenna with integrated GSM band and dual band notches.". *International Journal of RF and Microwave Computer Aided Engineering*, :pp. 1–10, 2018.

- [18] A. Ibrahim and W. Ali. “**High isolation 4-element ACS-fed MIMO antenna with band notched feature for UWB communications.**”. *International Journal of Microwave and Wireless Technologies*, :pp. 1–11, 2021.
- [19] M. Naser-Moghadasi, R. A Sadeghzadeh, R. K. Mohammadlou, M. Jalali, and B. S. Virdee. “**miniature planer monopole antenna with dual-band rejection characteristics for uwb applications.**”. *Microw. Opt. Technol. Lett*, 55:pp. 1977–1981, 2013.
- [20] K. Muzaffar and M. Idrees Magray. “**Compact Four Element Dual Band Notched Orthogonally Placed UWB Antennas for Wireless MIMO Applications.**”. *IEEE-APS Topical Conference on Antennas and Propagation in Wireless Communications*, : pp. 285–287, 2019.
- [21] S. M. A. Nezhad and H. R. Hassani. “**A novel triband E-shaped printed monopole antenna for MIMO application.**”. *IEEE Antennas Wirel. Propag. Lett*, 9: pp. 576–579, 2010.
- [22] A. Mallahzadeh, A. Sedghara, and S. M. A. Nezhad. “**A tunable multi-band meander line printed monopole antenna for MIMO systems.**”. *Proceedings of the 5th European Conference on Antenna and Propagation*, 230:pp. 315–318, 2010.
- [23] D. W. Browne, M. Manteghi, M. Fitz, and Y. Rahmat-samii. “**Experiments with compact antenna arrays for MIMO radio communications.**”. *IEEE Trans Antennas Propag*, 54:pp. 3239–3250, 2006.
- [24] H. Li, J. Xiong, and S. He. “**A compact planar MIMO antenna system of four elements with similar radiation characteristics and isolation structure.**”. *IEEE Antennas Wirel Propag Lett*, 8:pp. 1107–1110, 2009.
- [25] Y. Ding, Z. Du, K. Gong, and Z. Feng. “**A novel dual-band printed diversity antenna for mobile terminals.**”. *IEEE Trans Antennas Propag*, 55:pp. 2088–2096, 2007.
- [26] A. Zehforoosh and Y. Zehforoosh. “**Evaluation of a novel hook-shaped multiband monopole antenna based on the AHP method.**”. *IET Commun*, 16:pp. 266–273, 2022.
- [27] M. M. Alam, R. Azim, and N. M. Sobahi. “**A dual-band CPW-fed miniature planar antenna for S-, C-, WiMAX, WLAN, UWB, and X-band applications.**”. *Sci Rep*, 12:pp. 7584, 2022.
- [28] A. Mallahzadeh, A. Foudazi, and S. M. A. Nezhad. “**A small-size pentaband hand-shaped coplanar waveguide-fed monopole antenna.**”. *Microwave Opt Technol Lett*, 53, 2011.
- [29] M. S. Sharawi. “**Current misuses and future prospects for printed multiple-input, multiple-output antenna systems.**”. *IEEE Antennas Propag. Mag*, 59(2):pp. 162–170, 2017.
- [30] R. Chandel, A. K. Gautam, and K. Rambabu. “**Tapered fed compact UWB MIMO-diversity antenna with dual band-notched characteristics.**”. *IEEE Trans. on Antennas and Propa*, 66(4), 2018.