

Reduction of Mutual Coupling Between Two Circularly Polarized Magneto-Electric Dipole Antennas Using Metasurface Wall Polarization Converter for 5G Application

Mohammad Hossein Ashouri¹, Saeed Fakhte¹

1- School of Electrical and Computer Engineering, Qom University of Technology, Qom, Iran

Email: Mh.Ashouri69@gmail.com

Email: fakhte@qut.ac.ir (Corresponding author) 

ABSTRACT:

The mutual coupling issue between two Right Hand Circularly Polarized (RHCP) Magneto-electric (ME) dipole antennas is addressed in this study. To mitigate this issue, a Metasurface Polarization-Rotator (MPR) Wall is employed, resulting in effective minimization of the coupling effects. The innovative antenna design, with high gain, shows promise for 5G applications. It consists of two electric dipole plates with triangular corners positioned at the top, along with two plates acting as magnetic dipoles perpendicular to the ground plane. Additionally, the presence of four plates on the outer periphery of the antenna contributes to the improvement of the circular polarization (CP) performance of the antenna. The feeding structure is configured in a V-shape. Integration of the metasurface polarization-rotator led to a significant reduction in mutual coupling. On average, the mutual coupling is decreased by more than -20.5 dB, reaching impressive values of -45 dB at 2 GHz, -55 dB at 3.1 GHz, and -40 dB at 3.7 GHz when the MPR wall is placed between the ME antennas. The antenna demonstrates promising performance in terms of impedance bandwidth, with a remarkable value of 61.4% for $|S_{11}| < [-10\text{dB}]$. Furthermore, the axial ratio bandwidth for $\text{AR} < [3\text{ dB}]$ is 63.36%, representing an 11% increase compared to the configuration without the MPR Wall. The maximum right-hand circular polarization gain achieved by the antenna is 9.91 dB at a frequency of 3 GHz. Additionally, the maximum front-to-back ratio (FBR) is 37.6 dB at a frequency of 2.5 GHz. By comparing and analyzing the simulation results for the scenarios with and without the MPR Wall, it becomes evident that the MPR Wall does not significantly affect the parameters of gain, front-to-back ratio, and impedance bandwidth.

KEYWORDS: Mutual Coupling, Magneto-Electric Dipole Antenna, Wideband, High Gain, Metasurface Polarization - Rotator.

1. INTRODUCTION

The reduction of mutual coupling within antenna arrays has been a central focus of research in the antenna field for many years. This is of particular significance due to the escalating demand for high-gain antennas across various wireless communication systems. Array antennas, which involve placing antennas near each other at a distance of half a wavelength, are commonly employed to achieve heightened gain. However, the inherent proximity of these antennas gives rise to surface wave propagation and subsequent alterations in current distribution, leading to a decrease in antenna gain [1, 2]. Consequently, researchers have persistently explored strategies to augment the number of antennas in an array and reduce the interspacing between them while upholding optimal performance [3].

Numerous techniques have been explored for mitigating mutual coupling. One approach entails integrating side metallic walls with a minor resistive film on both sides of the dipole antenna [4]. Another method involves the

©The Author(s) 2024

Paper type: Research paper

<https://doi.org/10.30486/mjee.2023.1991539.1180>

Received: 15 November 2023; revised: 22 December 2023; accepted: 17 January 2024; published: 1 March 2024

How to cite this paper: M H. Ashouri, S. Fakhte, "Reducing the Mutual Coupling Between Two Circularly Polarized Magneto-Electric Dipole Antennas Using Metasurface Wall Polarization Converter for 5G Application", *Majlesi Journal of Electrical Engineering*, Vol. 18, No. 1, pp. 55-63, 2024.

utilization of a one-dimensional electromagnetic bandgap and a split-ring resonator positioned near two monopole antennas to curtail mutual coupling [5]. Furthermore, compact structures composed of electric dipoles, magnetic dipoles, and circular components have been employed as intermediary structures between two patch antennas to achieve mutual coupling reduction [6]. The emergence of metasurfaces has also proven effective in addressing mutual coupling reduction [7, 9].

In the face of the rapid progress of contemporary wireless communication systems, there is an escalating demand for broadband antennas characterized by consistent gain, catering to various generations of mobile Internet. The World Radiocommunications Conference in 2015 (WRC15) pinpointed frequency bands within the 24-86 GHz range as prospective candidates for future communications [10]. The Magneto-Electric (ME) dipole antenna emerges as a fitting contender for such applications owing to its favorable electrical attributes, encompassing substantial impedance bandwidth, stable gain, commendable front-to-back ratio, and low cross-polarization. ME dipole antennas possess the capacity to function across an extensive spectrum of wireless communication bands, including ultra-wideband systems [11, 12]. Notably, these antennas exhibit wideband characteristics while upholding stable gain [13].

A magneto-electric dipole antenna is a type of antenna that combines both magnetic and electric dipole elements to transmit or receive electromagnetic waves. The structure of a magneto-electric dipole antenna is illustrated in Fig. 1. This antenna comprises a half-wavelength electric dipole oriented horizontally (J) and a quarter-wavelength vertical cavity positioned above it, radiating similarly to a horizontal (M). The magnetic and electric dipoles are excited in an orthogonal and simultaneous manner. A feeding line, capable of exciting both the magnetic and electric dipoles simultaneously, is positioned at the center of the antenna and connected to the SMA connector [14-15].

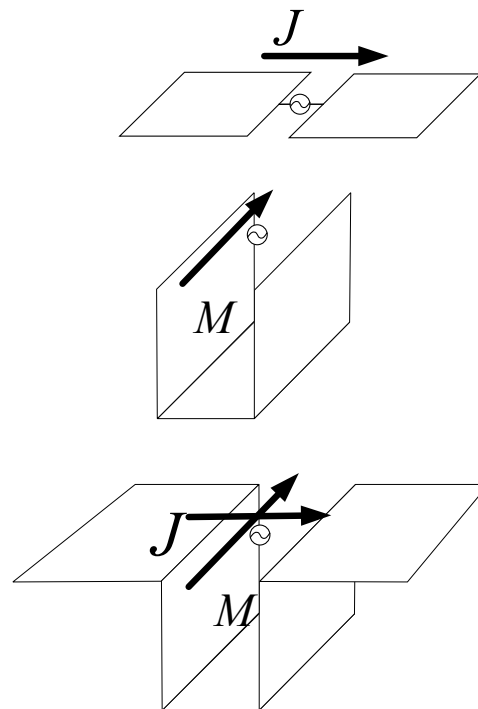

Fig. 1. How to combine electric dipole and magnetic dipole.

The radiation mechanism of a magneto-electric dipole antenna is illustrated in Fig. 2. In the horizontal (H) plane, the radiation pattern for magnetic dipoles takes the shape of an O, while in the vertical (E) plane, it resembles an 8. Conversely, electric dipoles exhibit the opposite radiation pattern in both planes compared to magnetic dipoles. However, when both magnetic and electric dipoles are excited with equal amplitude and proper phase, a cardioid-symmetric radiation pattern is achieved in both the E and H planes. This configuration effectively reduces radiation behind the antenna [16].

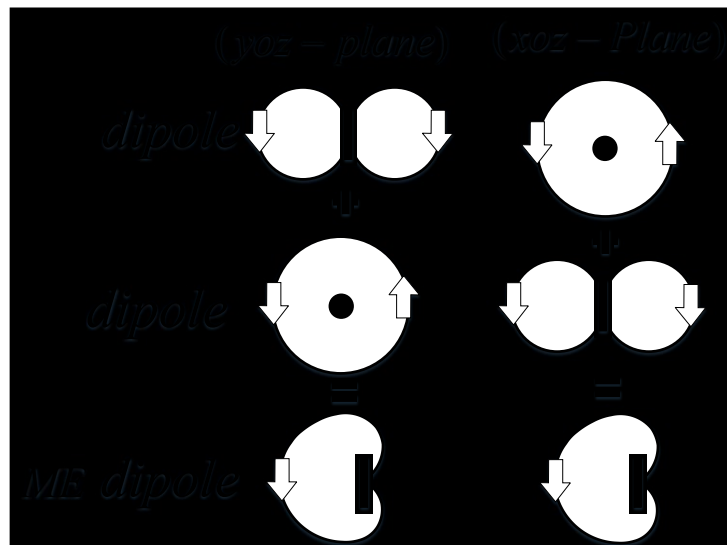

Fig. 2. Radiation mechanism of magneto-electric dipole antenna.

2. METASURFACE POLARIZATION -ROTATOR WALL

Fig. 3 illustrates the metasurface structure of the Metasurface Polarization-Rotator (MPR) Wall employed in this study. The size specifications of this structure are provided in Table 1. In a previous work referenced as [17], a 7×1 array of the same MPR structure is employed between two dielectric resonator antennas, serving the purpose of frequency conversion. In the current study, the identical MPR structure is utilized. In the present study, the same MPR structure is used except that a 4×1 array MPRs is used in this work. The number of unit-cell MPR used is experimental and definitely, the higher the number, the greater its effect on reducing the mutual coupling.

The metasurface material used in the Wall is Rogers RO5870, possessing a relative permittivity (ϵ_r) of 2.33. The metallic component of the MPR structure is fabricated using copper.

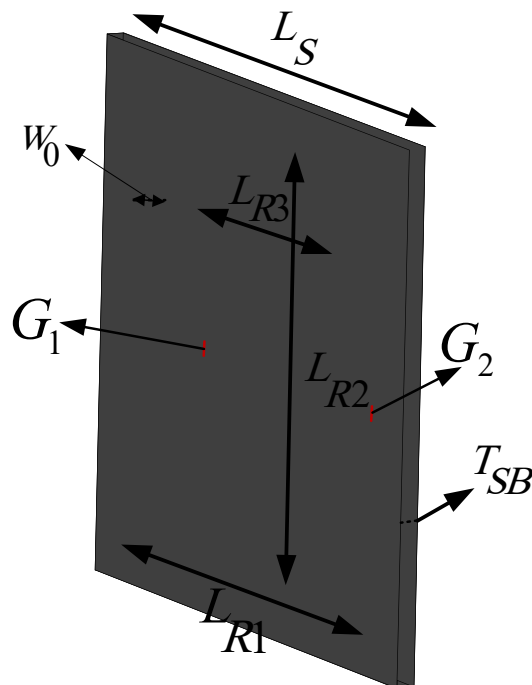

Fig. 3. The geometry of the MPR unit-cell.

Table 1. Dimensions of the used unit-cell MPR.

Parameter	Value/mm	Parameter	Value/mm
L_{R1}	49.8	L_S	63.20
L_{R2}	50.3	W_0	6
L_{R3}	28.8	T_{SB}	1
G_1	2.5	G_2	2.5

2.1. Antenna Configuring

Fig. 4 illustrates the geometry of the proposed antenna, while Table 2 provides the values of its parameters. In Fig. 2a, there are two vertical planes and two horizontally symmetrical planes featuring triangular corners, forming an electric dipole. The antenna is equipped with a V-shaped feeding structure, as shown in Fig. 4b. Fig. 4c provides a depiction of the MPR wall placed between the antennas.

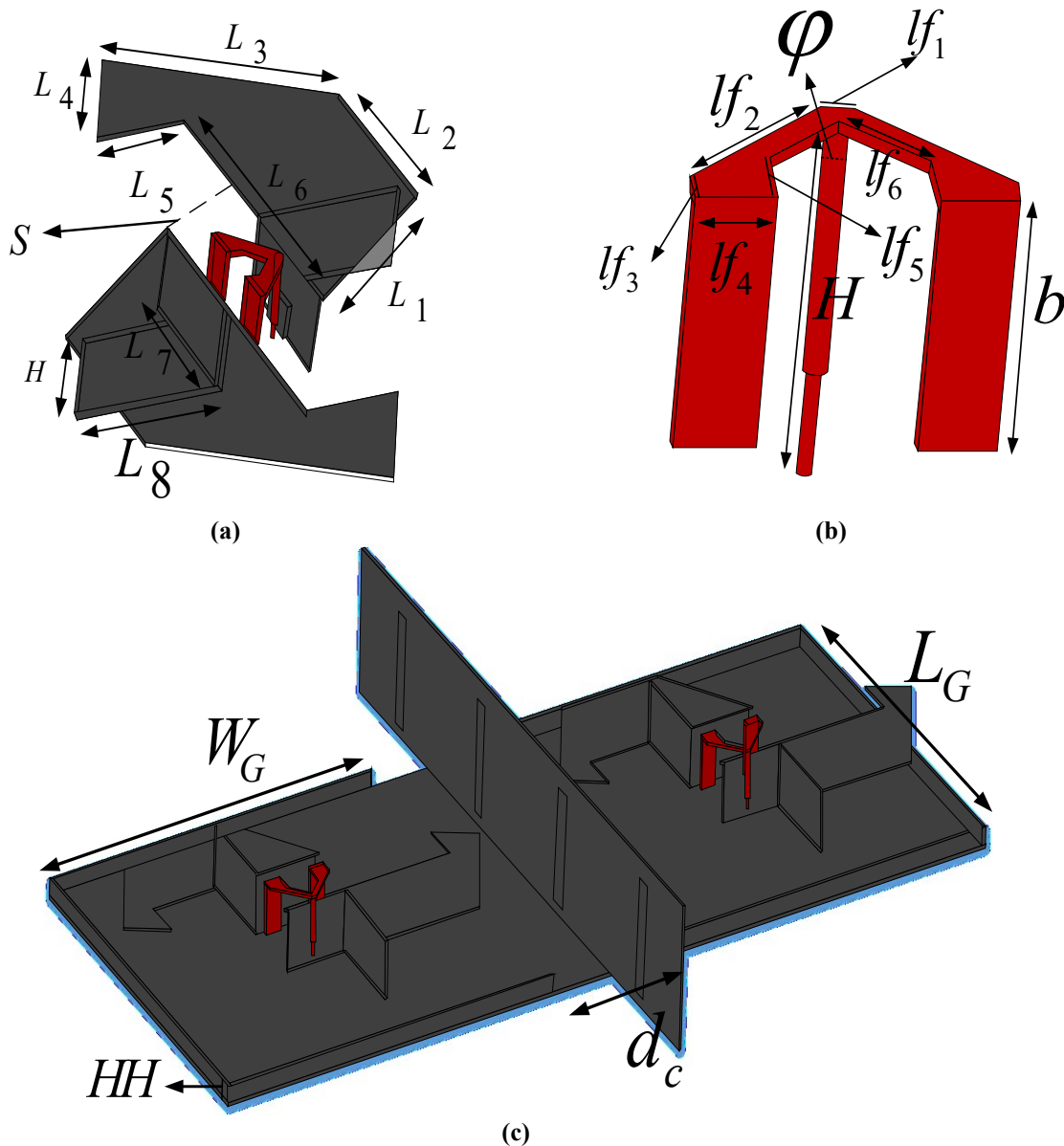

Fig. 4. (a) Magneto-electric dipole, (b) feed line, (c) overall view of the antenna with a 4x1 array MPR wal.

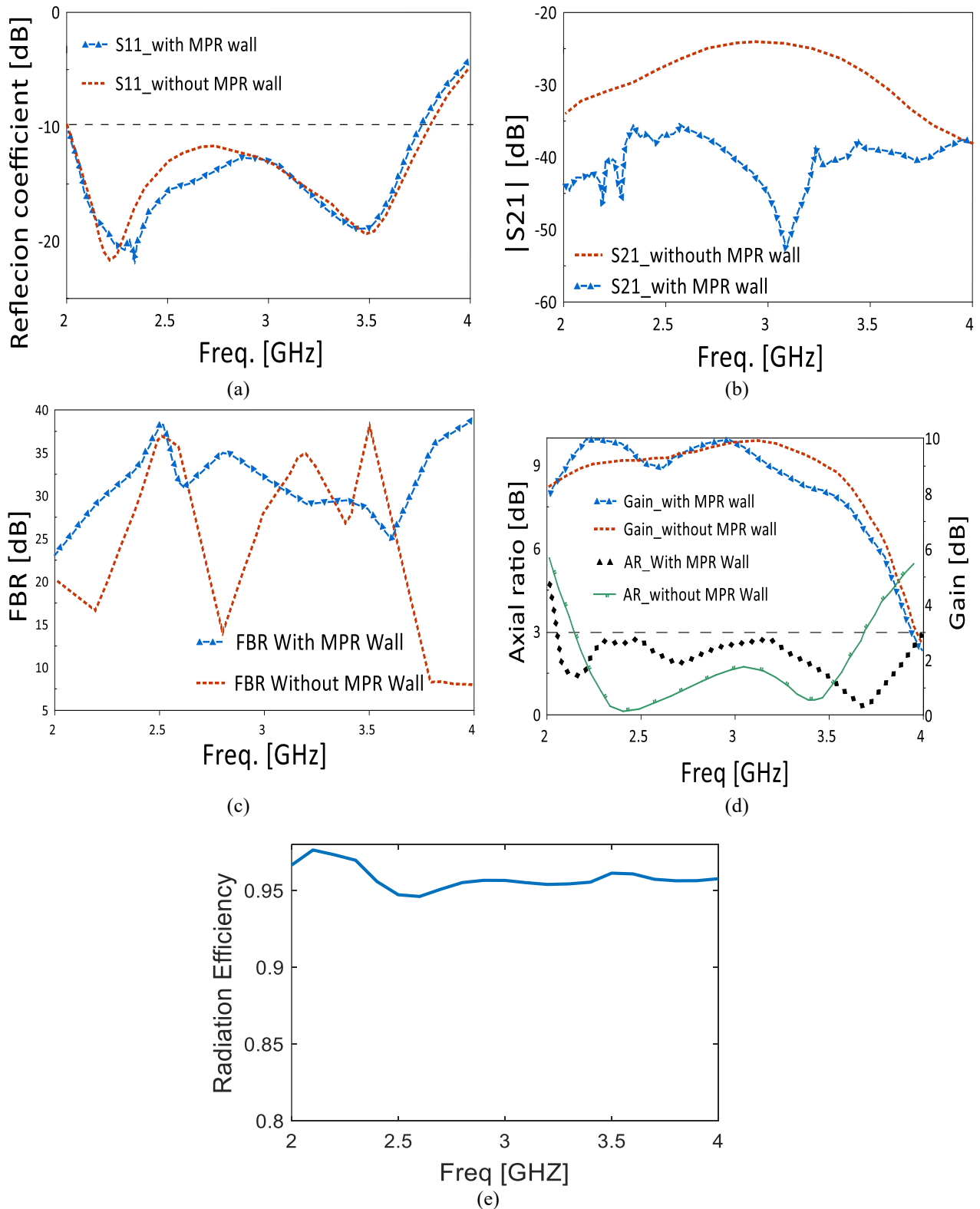

Fig. 5. (a) Impedance bandwidth diagram, (b) gain and axial ratio diagram, (c) front-to-back ratio diagram, (d) S21 diagram, and (e) radiation efficiency.

Table 2. Dimensions of the used ME Antenna.

Parameter	Value/mm	Parameter	Value/mm
WG	145	L7	25
LG	145	L8	30
HH	11.25	Lf1	2.5
S	24	Lf2	16.5
H	29	Lf3	3.2
L1	42	Lf4	6.5
L2	43.9	Lf5	6.5
L3	45.7	ϕ	2
L4	19	b	21
L5	14.7	BW	8
L6	4.4	dc	13.4

Fig. 5 displays the diagrams for the impedance bandwidth, gain, axial ratio, front-to-back ratio, and S21 for the cases with and without the MPR wall.

According to Fig. 5a, the impedance bandwidth diagram suggests that there is no significant difference between the antenna with and without the MPR Wall. Referring to Fig. 4, the impedance bandwidth for the antenna with the MPR Wall, where $|S_{11}| < [-10 \text{ dB}]$, covers 61.4% of the frequency range from 2 GHz to 3.75 GHz. Similarly, for the antenna without the MPR Wall, the impedance bandwidth spans 59.64% of the frequency range from 2 GHz to 3.7 GHz.

Referring to Fig. 5b, the addition of the MPR wall between the two mutually coupled ME antennas results in a reduction of over -20 dB in $|S_{21}|$ compared to the antenna without the MPR Wall. The magnitude of the S21 values at frequencies 2 GHz, 3.1 GHz, and 3.7 GHz is approximately -40 dB, -55 dB, and -45 dB, respectively.

In Fig. 5c, the presented antenna with the MPR wall achieves a maximum front-to-back ratio (FBR) of 37.6 dB at a frequency of 2.5 GHz. Conversely, for the setup without the MPR wall, the FBR is 37 dB at a frequency of 3.5 GHz.

Referring to Fig. 5d, the axial ratio bandwidth for the structure with MPR wall, with an $AR < [3 \text{ dB}]$, extends across 63.36% of the frequency range from 2.07 GHz to 3.99 GHz. In contrast, the axial ratio bandwidth for the structure without the MPR wall encompasses 52.73% of the frequency range from 2.15 GHz to 3.69 GHz. The axial ratio for the structure with the MPR wall setup exhibits an 11% increase.

Continuing with Fig. 5d, the maximum right-hand circularly polarized gain for the antenna with the MPR wall configuration is 9.91 dB at a frequency of 3 GHz. Conversely, for the structure without the MPR Wall, it is 9.92 dB at a frequency of 3.1 GHz. Fig. 5e displays the radiation efficiency of the proposed antenna. Observe that it is above 0.95 across the whole band.

Upon comparing and analyzing the simulation results for the structures with the MPR wall and without the MPR Wall, it becomes evident that the MPR wall does not significantly affect the gain, front-to-back ratio, and impedance bandwidth curves.

The radiation patterns of the antenna for the structure with the MPR wall are depicted in Fig. 6. From the figure, it is evident that the right-hand components dominate, and there is a noticeable cross-polar discrimination between the right-hand and left-hand components.



(a)

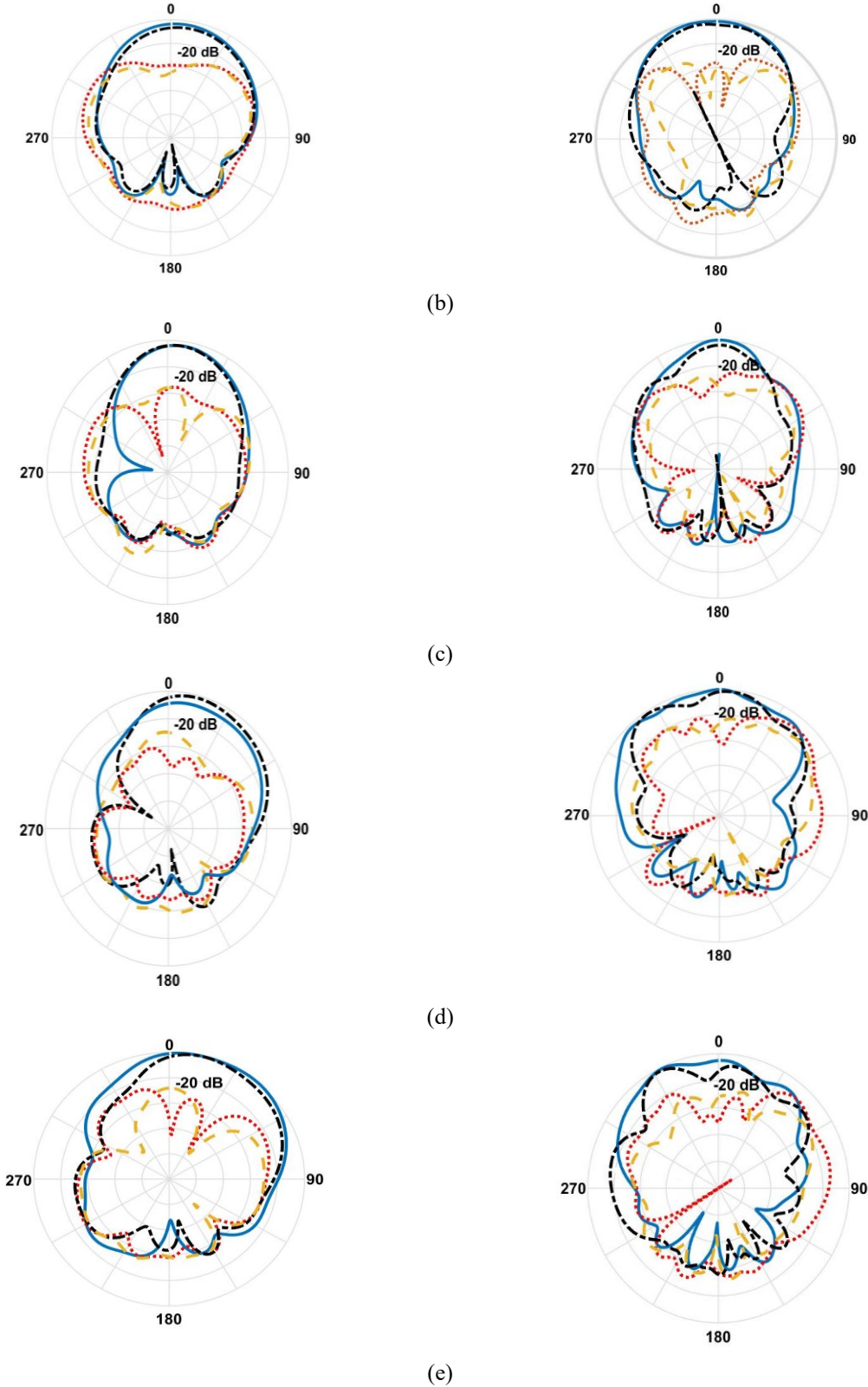

Fig. 6. The right-hand and left-hand radiation patterns for the antenna with MPR wall at (a) 2.2 GHz at (b) 2.6 GHz at (c) 3 GHz at (d) 3.5 GHz and (e) and 3.8 GHz for the used antenna. Solid blue and dashed black lines are measured and simulated RHCP components.

3. CONCLUSION

Using MPR walls for circular polarized antennas can pose challenges. The alteration in wave direction and refraction caused by the MPR wall, aimed at reducing cross-coupling, can directly impact the axial ratio plot. This challenge becomes crucial when applying MPR walls to Right-Hand Circularly Polarized (RHCP) ME dipole antennas. These antennas are typically designed with sidewalls that enhance the high aspect ratio plot by eliminating the sidewalls. This dilemma results in either a low-bandwidth antenna or the likelihood of the metal sidewalls substantially diminishing the effect of the additional surface wall from the polarization converter. Consequently, the performance of the MPR wall could be compromised. However, in this paper, the authors managed to overcome these challenges for the first time and achieve a notable reduction in cross-coupling by implementing an MPR wall between two RHCP ME dipole antennas.

In our proposed antenna design, which is the first instance of mutual cross-coupling between two circularly polarized magneto-electric dipole antennas, we achieved an impedance bandwidth of 61.4% for $|S_{11}| < [-10\text{dB}]$. The axial ratio bandwidth for $\text{AR} < [3\text{ dB}]$ is 63.36%, indicating an 11% increase compared to the configuration without the MPR Wall. The maximum right-hand circular polarization gain is achieved at 3 GHz. Upon comparing and scrutinizing the simulation results for the cases with and without the MPR Wall, it becomes apparent that the MPR wall does not significantly affect the parameters of gain, front-to-back ratio, and impedance bandwidth. By introducing the MPR wall between the two mutually coupled ME antennas, a reduction of over -20 dB is observed in comparison to the antenna lacking the MPR Wall. The S_{21} values at frequencies of 2 GHz, 3.1 GHz, and 3.7 GHz are all above -40 dB, -55 dB, and -45 dB, respectively.

Data Availability. Data underlying the results presented in this paper are available from the corresponding author upon reasonable request.

Funding. There is no funding for this work.

Conflicts of interest. The authors declare no conflict of interest.

Ethics. The authors declare that the present research work has fulfilled all relevant ethical guidelines required by COPE.



This article is licensed under a Creative Commons Attribution 4.0 International License.

©The Author(s) 2024

REFERENCES

- [1] Ludwig, "Mutual coupling, gain and directivity of an array of two identical antennas," *IEEE Trans. Antennas Propag.*, Vol. AP-24, No. 6, pp. 837–841, Nov. 1976.
- [2] K. S. Vishvakshnan, K. Mithra, R. Kalaiarasan and K. S. Raj, "Mutual Coupling Reduction in Microstrip Patch Antenna Arrays Using Parallel Coupled-Line Resonators," in *IEEE Antennas and Wireless Propagation Letters*, Vol. 16, pp.21462149, 2017.
- [3] S. Kim and S. Nam, "A Compact and Wideband Linear Array Antenna With Low Mutual Coupling," in *IEEE Transactions on Antennas and Propagation*, Vol. 67, No. 8, pp.5695-5699, Aug. 2019.
- [4] J Y. Lee, S. -H. Kim and J. -H. Jang, "Reduction of Mutual Coupling in Planar Multiple Antenna by Using 1-D EBG and SRR Structures," in *IEEE Transactions on Antennas and Propagation*, Vol. 63, No. 9, pp. 4194-4198, Sept. 2015.
- [5] S. Ghosal, A. De, R. M. Shubair and A. Chakrabarty, "Analysis and Reduction of Mutual Coupling in a Microstrip Array With a Magneto-Electric Structure," in *IEEE Transactions on Electromagnetic Compatibility*, Vol. 63, No. 5, pp. 1376-1383, Oct.2021.
- [6] H. M. Bernety and A. B. Yakovlev, "Reduction of Mutual Coupling Between Neighboring Strip Dipole Antennas Using Confocal Elliptical Metasurface Cloaks," in *IEEE Transactions on Antennas and Propagation*, Vol. 63, No. 4, pp. 1554-1563, April 2015.
- [7] Tang et al., "A Metasurface Superstrate for Mutual Coupling Reduction of Large Antenna Arrays," in *IEEE Access*, Vol. 8, pp. 126859-126867, 2020.
- [8] G. Moreno et al., "Wideband Elliptical Metasurface Cloaks in Printed Antenna Technology," in *IEEE Transactions on Antennas and Propagation*, Vol. 66, No. 7, pp.3512-3525, July 2018.
- [9] H. Luan, C. Chen, W. Chen, L. Zhou, H. Zhang, and Z. Zhang, "Mutual Coupling Reduction of Closely E/H-Plane Coupled Antennas Through Metasurfaces," in *IEEE Antennas and Wireless Propagation Letters*, Vol. 18, No. 10, pp. 1996-2000, Oct. 2019.
- [10] J. d. D. Ntawangaheza, L. Sun, Z. Xie, Y. Pang, Z. Zheng and G. Rushingabigwi, "A Single-Layer Low-Profile

- Broadband Metasurface Antenna Array for Sub-6 GHz 5G Communication Systems,"** in *IEEE Transactions on Antennas and Propagation*, Vol. 69, No. 4, pp. 2061-2071, April 2021.
- [11] J. Lai, B. Feng, Q. Zeng, and K. L. Chung, "**A substrate integrated magneto-electric dipole antenna using metasurface for 2G/3G/LTE/5G applications,**" 2017 Sixth Asia-Pacific Conference on Antennas and Propagation (APCAP), 2017.
- [12] Y. -L. Li and K. -M. Luk, "**Dual Circular Polarizations Generated by Self-Polarizing Fabry-Pérot Cavity Antenna With Loaded Polarizer,**" in *IEEE Transactions on Antennas and Propagation*, Vol. 69, No. 12, pp. 8890-8895, Dec. 2021.
- [13] Le-Wei Li, Mook-Seng Leong, Pang-Shyan Kooi, Tat-Soon Yeo, and Kian-Hwa Tan, "**Rectangular modes and dyadic Green's functions in a rectangular chiro waveguide. I. Theory,**" in *IEEE Transactions on Microwave Theory and Techniques*, Vol. 47, No. 1, pp.67-73, Jan. 1999.
- [14] T. Limpiti, A. Chantaveerod, & W. Petchakit, "**Design of a Magneto-Electric Dipole Antenna for FM Radio Broadcasting Base Station Antenna Implementation.**" *Progress In Electromagnetics Research M*, 60, 75–84. 2017.
- [15] Govindanarayanan, I., Rangaswamy, N. & Anbazhagan, R. "**Design and analysis of broadband magneto-electric dipole antenna for LTE femtocell base stations,**". *Journal of Computational Electronics* 15, 200–209 2016.
- [16] M. Li, & K.-M. Luk, **Wideband Magneto-electric Dipole Antennas.** In: Chen, Z. (eds) *Handbook of Antenna Technologies.* "Springer, Singapore, 2015.
- [17] M. Farahani, J. Pourahmadazar, M. Akbari, M. Nedil, A. R. Sebak and T. A. Denidni, "**Mutual Coupling Reduction in Millimeter-Wave MIMO Antenna Array Using a Metamaterial Polarization-Rotator Wall,**" in *IEEE Antennas and Wireless Propagation Letters*, Vol. 16, pp. 2324-2327, 2017.