



## Position Accuracy Improvement of the Inertial Navigation System using LSTM Algorithm without GNSS Signals

Mohammad Sabzevari<sup>1</sup>, MasoudReza Aghabozorgi Sahaf<sup>2</sup>

1- Electrical Engineering Department, Yazd university, Yazd, Iran.  
Email: m\_sabzevary@yahoo.com

2- Electrical Engineering Department, Yazd university, Yazd, Iran.  
Email: aghabozorgi@yazd.ac.ir (Corresponding author) 

### ABSTRACT:

Currently, satellite navigation systems on cars provide a promising means of making these vehicles unmanned in the future. There is a common problem with these systems due to the unavailability of satellite signals in tunnels, forests, and noisy areas. One of the methods used to solve this problem is by using inertial navigation systems as an auxiliary system. This system works by modeling errors and correcting them when GNSS signals are absent. A number of methods are available for error modeling such as Kalman filters, neural networks, and so on, each of which has its own advantages and disadvantages. The error of inertial navigation is modeled using LSTM deep neural networks in this article. In this neural network, the relationship between current and past data is modeled as long as the GNSS satellite signal is available to improve the output position of the inertial navigation system when the GNSS satellite signal can no longer be received. The proposed method has been tested on real car driving data, and the calculated position from the inertial navigation system in four maneuvers has been compared with the Extended Kalman Filter method outputs. According to the results of the experiments, the proposed algorithm has improved the position estimation by 60% on average during 30, 60, and 120 seconds without GNSS signals, compared to the inertial navigation system based on Extended Kalman filter.

**KEYWORDS:** Inertial Navigation System, GNSS, LSTM, Deep learning, Extended Kalman Filter, IMU.

### 1. INTRODUCTION

In our rapidly evolving world, navigation and routing are one of the most basic needs, which is why positioning systems in cars, ships, and aircraft, as well as research and development, have been used to improve the accuracy of these systems. One of the principles of navigation and guiding devices, especially cars in smart transportation systems, is to maintain a continuous, accurate, and powerful position [1]. A number of technologies are available for positioning in urban environments, such as radar, LIDAR, ultrasonic, cameras, etc. Satellite navigation systems and inertial navigation systems are among the most widely used systems [2].

The received signals from satellites are used by GNSS receivers to continuously report the position of the receiver with an accuracy of approximately 5 meters and an update rate of 10 Hz [3]. Even though this error value remains constant at all times, the main problem with these receivers is their dependence on the received signal, which can be absent in some areas such as tunnels, forests, buildings and areas with disturbing signals [3]. On the other hand, an inertial navigation system is independent of external signals and factors and is capable of calculating its position wherever it is. A major disadvantage of this system is the increase in positioning error over time, which is caused by the IMU sensor used [4].

The integration of satellites and inertial navigation systems is used today in order to overcome the disadvantages mentioned above. By using GNSS data and the Kalman filter algorithm, the error of the IMU sensor is modeled, so

©The Author(s) 2024

Paper type: Research paper

<https://doi.org/10.30486/mjee.2023.1992635.1192>

Received: 17 October 2023; revised: 25 November 2023; accepted: 27 January 2024; published: 1 March 2024.

How to cite this paper: M. Sabzevari, M.R. Aghabozorgi Sahaf, “**Position Accuracy Improvement of the Inertial Navigation System using LSTM Algorithm without GNSS Signals**”, *Majlesi Journal of Electrical Engineering*, Vol. 18, No. 1, pp. 45-53, 2024.

that in the absence of GNSS signals, the accuracy of the position can be increased by reducing the error of the IMU sensor. To integrate these two systems, a number of algorithms and methods have been presented, such as Bayesian filters, neural networks, fuzzy logic, etc. The most common of these methods are Bayesian filters, which are divided into two groups. An Extended Kalman Filter[5], Unscented Kalman Filter[6], Quadrature Kalman Filter[7], and Cubical Kalman Filter[8] are some methods from the first category, which use an approximate posterior probability density function in order to estimate the state of a system around an identified point. In the second category, Particle Filters[9], Gaussian Summation Filters[10], and RBPF filters[11] are included, which are based on an approximation of posterior probability density functions around all points of the sample space. Consequently, all methods attempt to reduce the complexity of the algorithm in order to increase the accuracy of variables estimation.

The development of neural networks has led to the presentation of many different methods for improving the accuracy of the inertial navigation system in the absence of GNSS signals, so that these methods are able to model a large number of complex nonlinear problems. For instance, Rashad and his colleagues used the RBF neural network to model both the output position and the error between inertial navigation and satellite navigation [12], Chiang utilized speed and heading angle as inputs to model the position and speed error[13]. Reference [14] describes a method for combining GNSS and INS data based on artificial neural networks, and [15] describes a method for estimating the position using fuzzy logic. In [16], authors utilized multilayer neural networks to combine DGPS and INS information. Reference [17] investigated the new multilayer feed forward neural network algorithm for combining GNSS and INS data, and its results were compared with the Kalman filter, showing that this algorithm is more effective than the Kalman filter.

In all the mentioned methods, static neural networks have been used by modeling using the data of the current and previous stage of INS data, and the neural network is used until the presence of the GNSS signal being trained, and then based on the latest information obtained, the trained neural network estimates the system error. In these methods, the main drawback is the inability to store dynamic data for long periods of time, which can cause inaccurate and unstable positioning during periods of long-term GNSS signal outages [18].

In this research, LSTM deep neural networks are used to resolve this problem. LSTM neural networks are a special type of recurrent neural networks that rely on more complex functions than recurrent neural networks, making them capable of memory adjustment and so solving the problem of long-term dependence in data.[19] In order to learn the proposed network, the output data of the IMU sensor, as well as the position and angles of the IMU are used as inputs, while the data received from the GNSS receiver is used as reference data. Until the GNSS signal is available, the trained network will learn the parameters of the Kalman filter, and if the signal is unavailable, the trained network will attempt to reduce the position error by estimating these parameters.

The remainder of the paper is organized as follows. The structure of the proposed system, including coupled integrated inertial navigation subsystems, and the structure of the proposed LSTM neural network are described in 2-4 sections. In Section 5, the proposed method is evaluated by experiment results. Finally, section 6 concludes the paper.

## 2. AN OVERVIEW OF THE PROPOSED NAVIGATION SYSTEM

A key feature of the proposed navigation system is the absence of auxiliary sensors such as cameras, speedometers, and steering angle sensors. Instead, only one IMU sensor and one GNSS receiver are used, the general structure of which is shown in Fig. 1.

According to this structure, there are two stages of learning and estimating. During the learning phase, the IMU sensors data including acceleration  $f_{ib}^b$  and angular velocity  $w_{ib}^b$  in body coordinates are entered into the inertial navigation system, and then position  $P_{INS}$ , velocity  $V_{INS}$ , and attitude  $A_{INS}$  are calculated.

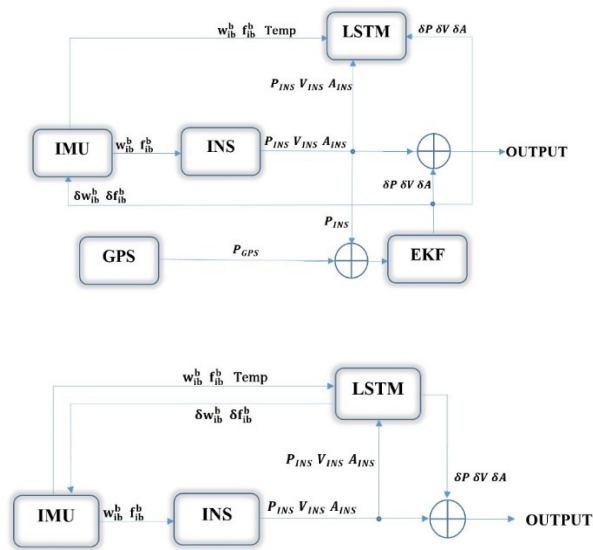

Fig.1. Structure of the proposed methodology. Up: learning phase. Down: prediction phase

The error of the IMU sensor is modeled by observing the position of the GNSS receiver position in conjunction with the Extended Kalman Filter. At any time, the inertial navigation system position and sensor errors can be corrected. The learning phase of the proposed LSTM neural network is carried out until the GNSS receiver signal is available and valid.

The input data of this deep neural network is, respectively, the output data of the IMU sensor along with its internal temperature and the position, velocity and attitude angles obtained from the inertial navigation system, as well as all state parameters of the Extended Kalman Filter which are used as reference data for training.

GNSS satellite signals are disrupted or multi-pathed in environments such as mountains, forests, tunnels, tall buildings, etc., which triggers the estimation stage of the proposed structure. In this case, the Extended Kalman Filter is removed and replaced with the trained LSTM neural network. The subsystems of this structure will be discussed in the following sections.

### 3. LOOSELY COUPLED INERTIAL NAVIGATION SYSTEM

Fig. 2 illustrates the typical schematic of a loosely coupled inertial navigation system. As shown in this figure, the collected data by the IMU sensor corresponds to the acceleration and angular velocity in the body coordinate is transmitted to the inertial navigation system which calculates the position (P), velocity (V), and attitude angles (A). Using the Kalman filter, the output from the inertial navigation system and the output from the IMU sensor are corrected based on the position error obtained from the inertial navigation system and the GNSS receiver[20].

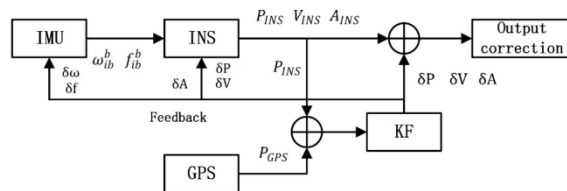

Fig. 2. Structure of the loosely coupled inertial navigation system[21].

Inertial navigation systems use following dynamic equations to calculate position, velocity, and attitude angles[21]. This article utilizes the 15-variable Extended Kalman Filter to model the inertial navigation system error, where equations (1) and (2) define state equations.

$$x_{\epsilon,k} = A_k x_{\epsilon,k-1} + w_k \quad (1)$$

$$x_{\varepsilon,k} = \begin{bmatrix} \delta P_{\varepsilon,k} \\ \delta V_{\varepsilon,k} \\ \delta A_{\varepsilon,k} \\ a_{\varepsilon,k}^b \\ d_{\varepsilon,k}^b \end{bmatrix} = A_k \begin{bmatrix} \delta P_{\varepsilon,k-1} \\ \delta V_{\varepsilon,k-1} \\ \delta A_{\varepsilon,k-1} \\ a_{\varepsilon,k-1}^b \\ d_{\varepsilon,k-1}^b \end{bmatrix} + w_k \quad (2)$$

In these equations  $\delta P_{\varepsilon,k}$ ,  $\delta V_{\varepsilon,k}$ ,  $\delta A_{\varepsilon,k}$ ,  $a_{\varepsilon,k}^b$  and  $d_{\varepsilon,k}^b$  are 3 x 1 vectors which indicate the error of position, velocity, attitude, the bias of gyroscope sensors and linear accelerometer sensors in the body coordinate respectively, and also  $w_k$  is a 1 x 15 vector which represents the noise of the process.

Also, in this article, the measurement process  $z_{\varepsilon,k}^b$  is expressed as a 6x1 vector according to equation (3) where  $P_{INS}$  and  $V_{INS}$  are 3x1 vectors respectively indicating the position and the velocity obtained from the inertial navigation system, and  $P_{GNSS}$  and  $V_{GNSS}$  are 3x1 vectors which express the position and the velocity obtained from the GNSS receiver.

$$z_{\varepsilon,k}^b = \begin{bmatrix} P_{INS,k} - P_{GNSS,k} \\ V_{INS,k} - V_{GNSS,k} \end{bmatrix} \quad (3)$$

According to these state equations, as long as the GNSS signal is available, the Extended Kalman Filter equations are updated, and when this signal is unavailable it seeks to reduce the accumulation error of the inertial navigation system output by estimating the state.

#### 4. STRUCTURE AND FUNCTION OF THE PROPOSED NEURAL NETWORK

By using feedback mechanism, STM deep neural networks operate very efficiently to estimate the next state of a system on time series data as input. In this article, this algorithm has been used to estimate the position of the inertial navigation system when there is no auxiliary data of the satellite navigation system. In this section, the network structure, important network parameters, and network training and testing conditions will be stated.

LSTM networks can use their feedback unit to store useful input information from the past period in their memory [22]. The LSTM neural network consists of four gates: input, forget, replacement and output gates which form the memory unit. The input gate of this network  $i_t$ , according to the following relations, determines whether or not input data is added to the previous state, where  $y_t$  represents the input of the network at time t, which includes angular velocity (1x3), linear acceleration (1x3) in three axis of the body coordinate, internal temperature of the IMU sensor, position (1x3), velocity (1x3) and altitude (1x3) obtained from the inertial navigation system in all three axes:

$$i_t = \sigma(w_i y_t + u_i h_{t-1} + b_i) \quad (4)$$

$$z_t = \tanh(w_z y_t + u_z h_{t-1} + b_z) \quad (5)$$

$$i_t = f_t \odot c_{t-1} + i_t \odot z_t \quad (6)$$

The forgetting gate determines what information from the previous state must be forgotten according to the following relationship:

$$f_t = \sigma(w_f y_t + u_f h_{t-1} + b_f) \quad (7)$$

Also, the output gate determines which information to keep in the next hidden state:

$$o_t = \sigma(w_o y_t + u_o h_{t-1} + b_o) \quad (8)$$

$$h_t = o_t \odot \tanh(c_t) \quad (9)$$

In these equations, h is the hidden state, c is the previous cell state, z is the replacement cell state, w and u are the weighting matrices, b is the bias matrix, and  $\odot$  is the Hadamard multiplication [23].

According to the stated content, the structure of the deep neural network used in this article is shown in Fig. 3. This network has an input layer, two hidden layers and an output layer. At any time, the time vector  $\{i(t), \dots, i(t-4)\}$  is used as input, where  $i(t)$  represents a 1x16 vector. The value of the last state in the last layer of this structure is entered into a fully connected layer with the Leaky ReLU activation function and its final output is the state vector  $x(t)$  expressed in equation (1). The important parameters of the proposed structure are listed in Table 1.

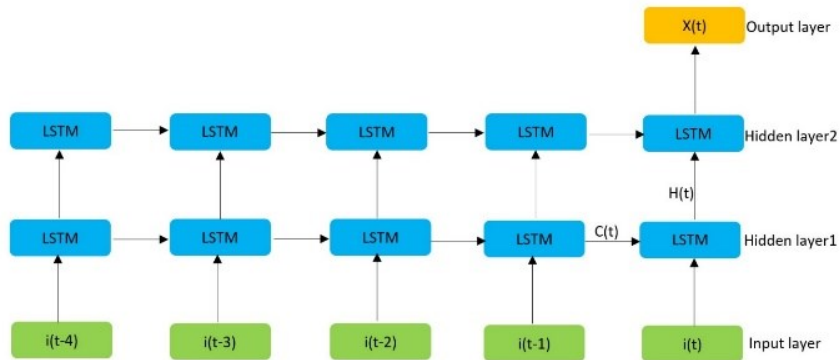

Fig. 3. Overall architecture of LSTM network.

Table 1. Specifications of the proposed LSTM neural network.

Feature	value
Activation Function	Leaky ReLU
Number of neurons	200
Learning rate	0.1
maximum number of epochs	100
batch size	50
Learning Algorithm	BPTT

### 5. EXPERIMENTS RESULTS

In order to check the performance of the proposed navigation system, all the tests have been performed on the real data recorded on the car in 4 different phases of driving. In these tests, two sensors IMU and GNSS, were used and tried to have the proper cost and accuracy. The technical specifications of these two sensors are listed in Table 2. For better performance, before performing each of these phases, the proposed system is first used for 8 hours at different times and in different phases without GNSS signal gap for learning.

Table 1. Technical specifications of sensors used in experiments.

	Feature	value
Gyroscope	Measurement range	$450^\circ/sec$
	In-Run Bias Stability	$20^\circ/h$
	Angular Random Walk	$3^\circ/\sqrt{h}$
	Rate Random Walk	$54^\circ/\sqrt{h^3}$
	Output noise	$0.16^\circ/sec$
	Update rate	50 Hz
Accelerometer	Measurement range	18g
	In-Run Bias Stability	0.1 mg
	Velocity Random Walk	$0.029 m/sec/\sqrt{h}$
	Output noise	1.5mg
	Update rate	50 Hz
GPS	Position accuracy	5 meter

	Update rate	10 z
--	-------------	------

**5.1. Phase 1**

The purpose of this phase is to investigate the effect of gyroscope bias on the performance of the proposed navigation system. In this phase of the test, after traveling a straight distance, the car turns around in an approximate circle path with 65 meters radius, and then the GNSS signal is cut off, and after 20 seconds, the car continues on a straight path, and again GNSS signal is connected after 10 seconds. The amount of time that the GNSS signal is not available is about 30 seconds. The behavior of the proposed navigation system compared to the GNSS receiver and inertial navigation based on the Extended Kalman Filter is shown in Fig. 4.

As can be seen, the proposed navigation system has achieved better accuracy when there is no GNSS signal. This test was repeated in the absence of GNSS signal for 60 and 120 seconds, and again the proposed navigation system performed better and was able to perform 60% better than the inertial navigation system based on the Extended Kalman Filter (Fig. 5).

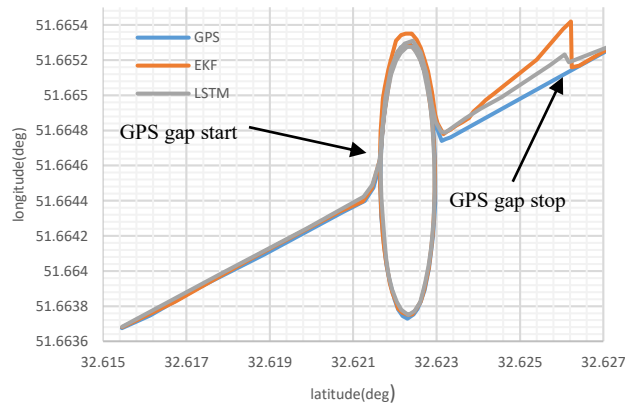

Fig. 4. Position error comparison result of GPS, EKF and LSTM in the first phase of the experiment.

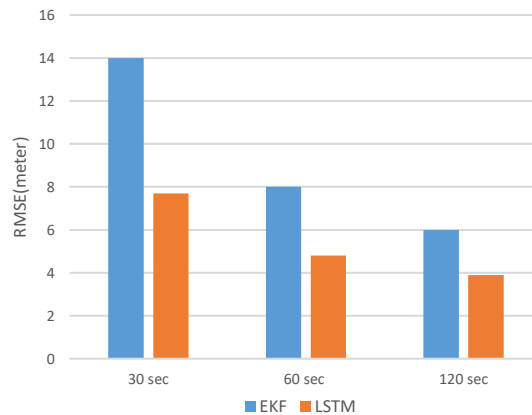

Fig. 5. Performance comparison of vehicle position during GNSS outage in the first phase of the experiment.

**5.2. Phase 2**

In this phase of the movement, for bias removing investigating, the accelerometers are in the straight path, so that the car moves in the straight path, and the input data of the GNSS receiver is disconnected for 30 seconds and reconnected again. As can be seen in Fig. 6, the proposed navigation system performed better than the inertial navigation system based on the Extended Kalman Filter and had less deviation than it. This test was also repeated in the absence of GNSS signal for 60 and 120 seconds, and again the proposed navigation system performed better and was able to perform 55% better than the inertial navigation system based on the Extended Kalman Filter (Fig. 7).

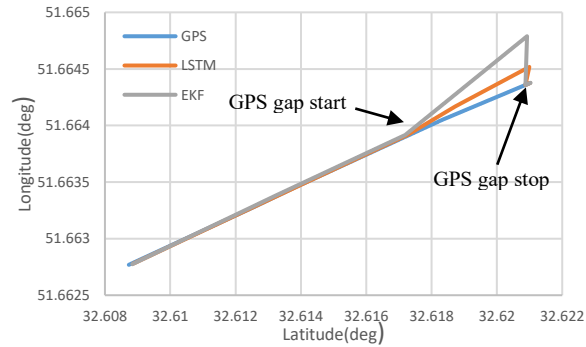

Fig. 6. Position error comparison result of GPS, EKF and LSTM in the second phase of the experiment.

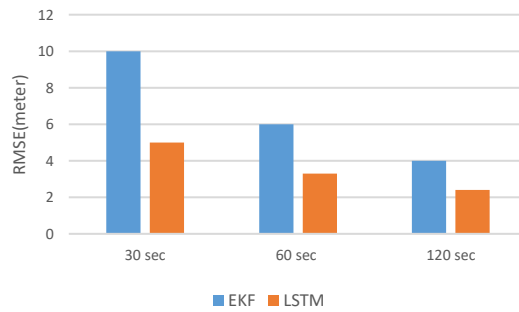

Fig. 7. Performance comparison of the vehicle position during GNSS outage in the second phase of the experiment.

### 5.3. Phase3

In this phase of the experiment, the bias effect of both accelerometer and gyroscope sensors on the proposed navigation system is evaluated. So at first, the car moves in a straight path and then after cutting the GNSS signal and continuing the straight path, the car turns right and the GNSS signal is connected again (Fig. 8). The duration of GNSS signal interruption is 30, 60 and 120 seconds, and the proposed navigation system has better performance than the inertial navigation system based on the Extended Kalman Filter, and its accuracy has been improved by an average of 60% (Fig. 9).

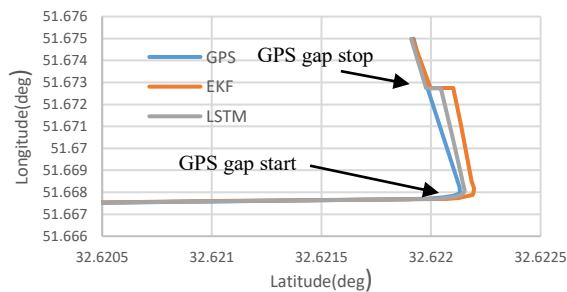

Fig. 8. Position error comparison result of GPS, EKF and LSTM in the third phase of the experiment.

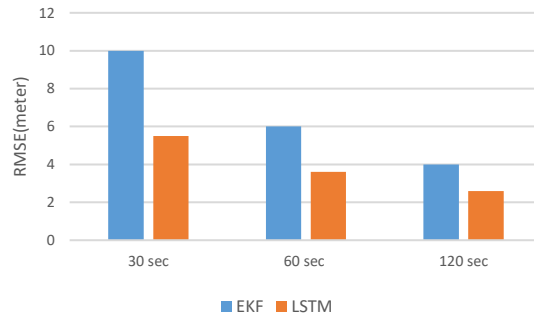

Fig. 9. Performance comparison of vehicle position during GNSS outage in the third phase of the experiment.

**5.4. Phase 4**

Considering that height increase and decrease by crossing bridges is inevitable, it is necessary to test the effect of IMU sensors in the third dimension(Z) as well. For this reason, in this phase of the experiment, the car moves in a straight path, and after cutting the GNSS signal, it goes up over a bridge and after going down and continuing to move, GNSS signal is connected again (Fig. 10). At times of 30, 60 and 120 seconds of signal interruption, this test is repeated and the results show that the proposed navigation system has better performance than the inertial navigation system based on the Extended KalmanFilter and has improved its accuracy by an average of 65% (Fig. 11).

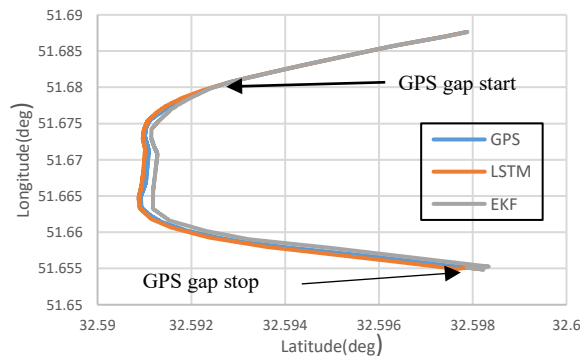

Fig. 10. Position error comparison result of GPS, EKF and LSTM in the fourth phase of the experiment.

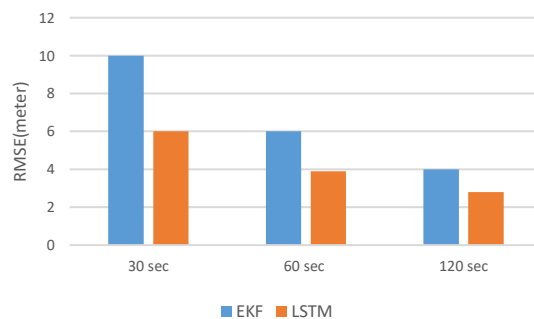

Fig. 11. Performance comparison of vehicle position during GNSS outage in the fourth phase of the experiment.

**6. CONCLUSION**

Today, the use of inertial navigation in unmanned vehicles is mandatory so that navigation can be done in situations such as forests, tall buildings, tunnels, etc., where the GNSS signal is not available. For this purpose, in this article an inertial navigation system based on LSTM neural networks is introduced and compared with the inertial navigation system based on the Extended Kalman Filter, which is the most common type of this system.



As long as the GNSS signal is available, the proposed neural network is in the learning phase, and when this signal is unavailable, it is used as a replacement for the Extended Kalman Filter. This system has been evaluated on the real data taken by the car and in 4 different maneuvers, and it has the ability to perform better than the inertial navigation system based on the Extended Kalman Filter and improves its accuracy by 60%.

## REFERENCES

- [1] L. Delobel, R. Aufrere, C. Debain, R. Chapuis, and T. Chateau, "A realtimemap refinement method using a multi-sensor localization framework," *IEEE Trans. Intell. Transp. Syst.*, Vol. 20, No. 5, pp. 1644–1658, May 2019.
- [2] E. Zhang and N. Masoud, "Increasing GPS localization accuracy with reinforcement learning," *IEEE Trans. Intell. Transp. Syst.*, Vol. 22, No. 5, pp. 2615–2626, May 2021.
- [3] D. Wang, Y. Dong, Z. Li, Q. Li, and J. Wu, "Constrained MEMS-based GNSS/INS tightly coupled system with robust Kalman filter for accurate land vehicular navigation," *IEEE Trans. Instrum. Meas.*, Vol. 69, No. 7, pp. 5138–5148, Jul. 2020.
- [4] J. K. Suhr, J. Jang, D. Min, and H. G. Jung, "Sensor fusion-based low cost vehicle localization system for complex urban environments," *IEEE Trans. Intell. Transp. Syst.*, Vol. 18, No. 5, pp. 1078–1086, May 2017.
- [5] F. Li and L. Chang, "MEKF With Navigation Frame Attitude Error Parameterization for INS/GPS," *IEEE Sensors Journal*, Vol. 20, No. 3, pp. 1536–1549, 2020.
- [6] K. Ryu, J. Kang and D. Lee, "Performance Comparison between EKF and UKF in GPS/INS Low Observability Conditions," *21st International Conference on Control, Automation and Systems (ICCAS)*, Korea, pp. 1911–1916, 2021.
- [7] H. Benzerrouk, R. Landry, V. Nebylov and A. Nebylov, "Robust INS/GPS Coupled Navigation Based on Minimum Error Entropy Kalman Filtering," *27th Saint Petersburg International Conference on Integrated Navigation Systems (ICINS)*, Russia, pp. 1–4, 2020.
- [8] W. Guangcai, X. Xu, and T. Zhang, "M-M estimation based robust cubature Kalman filter for INS/GPS integrated navigation system," *IEEE Trans. Instrum. Meas.*, Vol. 70, 2021,
- [9] M.S. Arulampalam and et al., "A tutorial on particle filters for online nonlinear/non-Gaussian Bayesian tracking," *IEEE Transactions on signal processing*, pp. 174–188, 2002.
- [10] D. Alspach, H. Sorenson, "Nonlinear Bayesian estimation using Gaussian sum approximations," *IEEE Trans. Automatic Control*, pp. 439–448, 1972.
- [11] C. Andrei and M. Hever, "Q-Learning Model Covariance Adaptation of Rao-Blackwellized Particle Filtering in Airborne Geomagnetic Navigation," *IEEE/ION Position, Location and Navigation Symposium (PLANS)*, Monterey, CA, USA, pp. 143–149, 2023.
- [12] Sharaf, R.; Noureldin, A. "Sensor integration for satellite-based vehicular navigation using neural networks," *IEEE Trans. Neural Netw.*, Vol. 18, pp. 589–594, 2017.
- [13] K.W. Chiang, A. Noureldin and N. El-Sheimy, "Multi-sensors integration using neuron computing for land vehicle navigation," *GPS Solution*, Vol. 6, No. 3, pp. 209–218, 2003.
- [14] M. Forrest, T. Spracklen, and N. Ryan, "An inertial navigation data fusion system employing an artificial neural network as the data integrator," in *Proc. ION NTM*, Anaheim, CA, pp. 153–158, 2000.
- [15] C. Toth, D.A. Grejner-Brzezinska and S. Moafipoor, "Pedestrian Tracking and Navigation Using Neural Networks and Fuzzy Logic," *IEEE International Symposium on Intelligent Signal Processing*, Alcalá de Henares, Spain, pp. 1–6, 2007.
- [16] A. Noureldin, A. ElShafie, M. Bayoumi, "GPS/INS Integration Utilizing Dynamic Neural Networks for Vehicular Navigation," *Inf. Fusion*, pp. 48–57, 2011.
- [17] El-Sheimy, N.; Chiang, K.-W.; Noureldin, A., "The utilization of artificial neural networks for multisensor system integration in navigation and positioning instruments," *IEEE Trans. Instrum. Meas.*, Vol. 55, pp. 1606–1615, 2006.
- [18] J. Liu and G. Guo, "Vehicle Localization During GPS Outages With Extended Kalman Filter and Deep Learning," *IEEE Transactions on Instrumentation and Measurement*, Vol. 70, pp. 1–10, 2021.
- [19] S. Hosseinyalamdary, "Deep Kalman Filter: Simultaneous Multi-Sensor Integration and Modelling; A GNSS/IMU Case Study," *Sensors*, 2018.
- [20] J. Chang, L. Zhang, L. -T. Hsu, B. Xu, F. Huang and D. Xu, "Analytic Models of a Loosely Coupled GNSS/INS/LiDAR Kalman Filter Considering Update Frequency Under a Spoofing Attack," *IEEE Sensors Journal*, Vol. 22, No. 23, pp. 23341–23355, 2022.
- [21] W. Fang et al., "A LSTM algorithm estimating pseudo measurements for aiding INS during GNSS signal outages," *Remote Sens.*, Vol. 12, No. 2, p. 256, Jan. 2020.
- [22] Xingjian, S.H.I., "Convolutional LSTM network: A machine learning approach for precipitation nowcasting," *Adv. Neural Inf. Process. Syst.* Vol. 28, pp. 802–810, 2015.
- [23] J. Ma, H. Liu, C. Peng, and T. Qiu, "Unauthorized broadcasting identification: A deep LSTM recurrent learning approach," *IEEE Trans. Instrum. Meas.*, Vol. 69, No. 9, pp. 5981–5983, 2020.