



A Multi-Input Single-Ended Primary Inductor Converter (SEPIC): Performance Analysis for Hybrid Sources of Renewable Energy

Nayeem Ahmed¹, Afrid U. Araf², Sheikh M. A. Rakeen³

1- Faculty of Electrical and Computer Engineering, Technische Universität Dresden, Dresden, Saxony, Germany.

Email: nayeemahmed811@gmail.com (Corresponding author) 

2- Department of Science and Engineering, Curtin University, Perth, Western Australia, Australia.

Email: a.araf@postgrad.curtin.edu.au

3- Department of Electrical and Electronic Engineering, BRAC University, Dhaka, Bangladesh.

Email: sheikh.mustahsin.ahmed.rakeen@g.bracu.ac.bd

ABSTRACT:

This paper focuses on the hybridization of two renewable energy sources (i.e., PV Panel and Bi-Cycle Dynamo) and the use of a Multi-Input SEPIC converter for highly efficient output from them. This paper has also presented the comparative assessment between the conventional Single-Input Single Output SEPIC (Single Ended Primary Inductor Converter) and Multi-Input SEPIC converter based on performance analysis. Both the Multi-Input SEPIC that is designed in this literature powered by the hybrid architecture of power sources and the Single-Input SEPIC are run in boost mode. The project is mainly developed with a view to facilitating the isolated rural islands and regions detached from the on-grid connections. The findings and assessments of this study are corroborated by the MATLAB/Simulink simulation results and optimally designed prototype built for miniature applications. The Multi-Input SEPIC topology has been developed in such a way that it is functional with an input voltage of 12.1V exactly and gives an output voltage of DC 53V approximately at the output terminal. To get the maximum voltage at the output from the designed circuit, the duty cycle of the converter recorded is almost 81.49%. The renewable energy sources (RES) that are used to build the prototype are Photovoltaic Panel and Bi-Cycle Dynamo. Due to the limitations of the PV Panels to generate power during the night and gloomy weather, the Bi-Cycle dynamo works as the backup power source. In performing the hardware and software analyses, various intermittent situations, solar irradiation, seasonal change, day-night phase, and other parameters are taken into consideration on the input terminal of the converter. An efficiency of 91.6% is obtained from the proposed hardware field-test analysis.

KEYWORDS: SEPIC Converter, Hybrid Renewable Energy Sources, Voltage Optimization, Rural Insular Area, Bi-cycle Dynamo, Solar Energy, Off-Grid Solution.

1. INTRODUCTION

Global warming, rising fuel costs, and geopolitical tensions worldwide are fueling the popularity of renewable energy and production from decentralized renewable energy sources like bi-cycle pedal dynamo getting the favorable trend. Renewable energy is earning trust through its contribution to meeting the demand for energy without deteriorating environmental conditions [1]. As a developing nation, Bangladesh is facing a higher demand for energy compared to its production and countrywide, the on-grid electricity supply is not available to the rural population. In these circumstances,

©The Author(s) 2024

Paper type: Research paper

<https://doi.org/10.30486/mjee.2024.1995734.1247>

Received: 15 September 2023; revised: 8 October 2023; accepted: 22 November 2023; published: 1 March 2024

How to cite this paper: N. Ahmed, A. U. Araf, and Sh. M. A. Rakeen, "A Multi-Input Single-Ended Primary Inductor Converter (SEPIC): Performance Analysis for Hybrid Sources of Renewable Energy", *Majlesi Journal of Electrical Engineering*, Vol. 18, No. 1, pp. 165-178, 2024.

decentralized RES (Renewable Energy Source) can mitigate the energy crunch in rural areas. According to its geographical position, Bangladesh is situated in a very suitable location for extracting solar power and currently, the government has focused on this sector which will definitely alleviate the demand pressure on the national grid of the country [2]. As per the Sustainable and Renewable Energy Development Authority (SREDA) of Bangladesh, the amount of solar electricity installed off-grid as of 2021 will be close to 346.19 MW. While the on-grid solar power capacity is close to 136.6 MW, a total of 482.79 Megawatts of solar energy has been installed nationwide [3].

The establishment of microgrids by the government to provide electricity to isolated rural residents has gotten simpler as renewable energy gains favor in the nation. However, because they depend so heavily on variables like weather, climate, timeframe, temperature, and geographical position renewable energy sources are particularly unpredictable in terms of electricity delivery [4]. This phenomenon has led researchers to mix up more than one RES to increase the efficiency of a system. To offset the very stochastic behavior of the RES, several renewable energy sources can be added up to get better performance and make the system more and more acceptable [5]. In this case, a bi-cycle mounted dynamo can be a viable solution as a backup source apart from the photovoltaic modules.

In a hybrid topology, adding a bicycle with a dynamo in addition to the PV module has shown to be a significant solution, especially for underprivileged rural residents. Rural people use bi-cycles as the fundamental mode of transportation very much and so, managing a bi-cycle to convert it into a power generation machine may not be a tough task for them. This solution is also cheaper and economically viable in terms of the cost of the other available RES. It is proven that a healthy male can generate 150 Watts of power by continuously pedaling [6]. Most importantly, unlike the photovoltaic modules, the bi-cycle dynamo doesn't depend on weather and temperature at all. And, it becomes a significant advantage for incorporating the bi-cycle mounted generator with PV panels for better outcomes. Bicycle dynamo turns mechanical energies into electrical ones. The addition of a bi-cycle dynamo therefore can be a cheaper solution as a support source for the solar panels in a system.

Power electronics DC-DC converters become a crucial part of a renewable energy system as energy generated from the RES has a very low-level voltage that needs to be stepped up before supplying to the demand side. Especially, the PV panels supply a low voltage at the output terminal which is not sufficient for the loads [7]. So, it is a must to raise to grid voltage level before injecting the power of the photovoltaics [8]. The DC-DC converter that has been deployed between the photovoltaics and the loads should have a high voltage conversion gain. It may be hypothesized that an enormous number of solar panels can be connected in series connections to produce a high output voltage, eliminating the requirement for high-gain DC-DC converters. In that case, there will be a new complication for the overall system, for example, partial shadowing [9]. Moreover, a system's efficiency is very much interconnected with the choice of appropriate converters [10]. Also, a higher voltage gain from the output of the converters can reduce the system's power loss very much. Therefore, because of the low output voltage of the RES such as photovoltaic arrays and fuel cells, the main concern in renewable grid-connected energy applications is to obtain high step-up and high-efficiency DC-DC converters [11].

Conventional DC-DC converters can be utilized in the RES but they have some limitations as their voltage conversion gains need to be improved for accurate utilization in renewable energy applications. Though they can achieve high gains at the output because of the higher duty cycle in the switching part of the converters, their performance drops by a significant amount [12]. To facilitate multiple renewable energy sources through a single piece of converter circuit, a Multi-Input converter (MIC) can be a better option than using single conventional converters separately. MIC, a centralized controller, and straightforward energy management strategies reduce the degree of complexity and the dimension of static converters [13]. By reducing the total number of system components, the multiport converter will also increase operating flexibility [14]. Also, compared to typical solutions that use several single converters for Multi-Input systems, this offers the most economical operation and enhances the system's functionality and efficiency by using less power [15]. On the other hand, SEPIC converters are included in the Buck-Boost converter family which are able to both step up or down the input voltage. The duty cycle of the controller transistor (i.e., MOSFET or IGBT) manages the output voltage of the SEPIC converter [16]. Moreover, the voltage at the output terminal is in the same polarity similar to the input, and a Multi-Input SEPIC will have the same basic advantages as a Single Input one [17]. A high-voltage gain may be produced by a quadratic SEPIC converter with a continuous input current for use in microgrids' renewable applications [18].

On the integration of hybrid renewable energy sources into the input port, numerous research studies have been conducted on Multi-Input converters. Anuradha et al., in their paper, proposed and designed a three-port Multi-Input SEPIC converter for adding multiple RES simultaneously. According to their study, a Multi-Input technology can eventually increase the typical DC-DC converters' efficiency. They proposed both uni-directional and bi-directional converters in their study [19]. Zhao demonstrated an industry-standard SEPIC design that was transformed into a Multiple-Input DC-DC converter where a single DC main bus can accommodate multiple scattered generating sources [20]. In Sangalad's work, the SEPIC converter with two inputs was described. As per him, a double-input SEPIC is

capable of reducing expenses and loss instead of two different converters with single-input configurations for various power sources [21]. Based on the Multi-Input SEPIC converter, Mohanty's test demonstrated that a battery can be added to the output terminal. Because of its buck-boost capability, the SEPIC converter can both charge and discharge an energy storage device [22]. There isn't a single topology that can satisfy all of the requirements for cost, durability, adaptability, productivity, and versatility like the Multi-Input Single Output converters according to the research of Rehman on Multi-Input DC-DC converters [23]. Utilizing a new Multi-Input converter architecture that can combine diverse power sources with various voltage-current characteristics was described in Khaligh's works [24]. In their literature, Wu et al. examined many multiport converter designs with a DC link inductor [25]. Wang proposed a double-input Buck-Boost converter with a coupled inductor. He used wind turbines and photovoltaics as power sources and fuel cells as energy storage devices [26]. Patra et al. in their paper proposed a Single Input Multi Output converter technology. Simultaneously, their converter generated boost, buck and inverter output. Though their topology can integrate n number of loads at the output, it can only facilitate a single input which is impractical for the mixture of renewable energy sources [27]. Reference [28] exhibited a MIC system based on a non-isolated double-boost converter appropriate for the hybridization of RES which also can handle bi-directional power flow at the storage batteries. Moreover, lacking the transformers the converter is capable of operating perfectly, allowing the input of clean energy sources to function independently. Reference [29] addressed in the literature of Multiple Input Multi Level Output (MIMLO) converters that the result of the experiment manifested that the converter with Multi-Input voltage has a great rate of conversion and excellent productivity with fewer components. Reduction in the number of converters led to the cheaper cost of building a system by incorporating DC-DC MIC for hybrid RES in reference [30]. Moury et al. in their paper described a novel technique for MIC with a quasi-resonant soft-switch system. The system also integrated power factor correction techniques for hybrid RES [31]. Deihimi in his research work presented a Step-Up DC-DC MIC. The design confirmed efficient voltage gains by increasing the number of input sources of voltage and low output voltage ripple by experimental analysis [32].

In this article, the Multi-Input topology of the SEPIC converter has been proposed and developed to integrate multiple renewable energy sources before supplying power to the loads. The primary agenda of this research is to build an energy production system suitable for rural insular off-grid islands and areas. To make a system financially viable and more efficient, more than one RES needs to be added up. To make the hybridization of renewable sources, a photovoltaic module along with a bi-cycle dynamo has been deployed simultaneously. Both of the sources are made sure that they are supplying a constant of 12V at the input terminal of the modified converter. Additionally, a comparative analysis is also presented between the Single-Input SEPIC and the proposed Multi-Input Single SEPIC converter. The proposed converter is designed such that it can accept n number of sources if required with further modification. The operability of the proposed design is analyzed and assessed using MATLAB/Simulink software and in addition to that, a hardware system as prototype is built to justify the feasibility of the system. Software data such as total power output, input power from RES, load voltage etcetera is shown. The test results uphold the Multi-Input SEPIC converter's superiority over conventional Single-Input SEPIC converters.

The information in the literature has been divided into sections where different facets of the topics have been explored. In Section 2, the methodology contains details on the overall proposed system. Furthermore, subsection 2.1 discusses the practical hardware prototype for field test purposes. Subsection 2.2 shows a brief discussion on a special circuit that is used in this project named "Reverse Voltage Polarity Protection Circuit". Subsection 2.3 and subsection 2.4 manifest the hardware part related to the Single-Input conventional DC-DC SEPIC converter and key elements to build up the system respectively. Section 3 covers a brief theoretical discussion on both Single-Input and Multi-Input SEPIC converters. The software simulation part is discussed in section 4 which includes the circuit block in MATLAB/Simulink software. Next, the results and analysis information for both the software and hardware analyses are all contained in section 5. Finally, the conclusion of the literature is summed up in section 6.

2. METHODOLOGY

This research proposes a system that will mitigate the energy demand of the rural poor people living in off-grid regions in a sustainable manner. Additionally, this research also aims to reduce the pressure on electricity generation from fossil fuel sources. The practicability of the proposed design is analyzed through software simulation data and a small-scale prototype. Solar PV module is supported by power generated from bi-cycle dynamo as a secondary source of this proposed approach. In addition, a Multi-Input SEPIC converter is added for a more efficient power supply to the load port. Power from photovoltaic panels depends on the irradiation and temperature on the panel's surface and the charge controller device is deployed for a constant output at the load terminal. A controller circuit is also added with the bi-cycle dynamo to ensure constant voltage supply from that source as supply from this source is highly fluctuating in nature depending on the speed of the pedaling. Fig. 1 displays the streamlined structure of the proposed design.

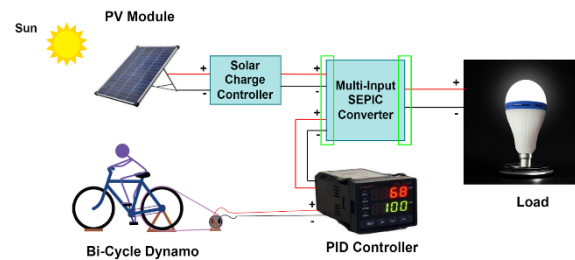

Fig. 1. Generalized Layout of the Proposed Structure

The photovoltaic-based bi-cycle dynamo is added using a modified Multi-Input SEPIC converter. The proposed hybridization has taken place to reduce the effect of the stochastic constraints of the solar modules. The modified Multi-Input proposed converter of this literature can allow n number of sources at the input terminal though only two sources are connected in this research. The generalized architecture of the Multi-Input SEPIC converter is manifested in Fig. 2.

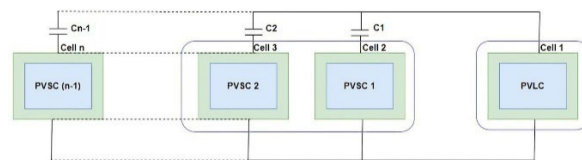

Fig. 2. Generalized Architecture of the Multi-Input (n -port) SEPIC Converter [19].

The suggested system setup demonstrates that by connecting or disconnecting the additional voltage sources, the number of input terminals may be altered even more. The Multi-Input DC-DC SEPIC converter in this study is constructed with four ports in total. Among them, two are the input terminal, one is for the energy storage terminal and another one is the load terminal.

2.1. Complete Project Prototype

In Fig. 3 the entire project prototype built for the field test is displayed. The primary source of the hardware prototype is a PV panel and the secondary source is the bi-cycle where a hub dynamo is mounted at the rear side of the cycle. By altering the rear tire and affixing a belt to it, the dynamo pulley can be driven by pedaling. There is a chassis made of iron installed to support the dynamo and stop giggling while pedaling. The voltage at the output terminal of the secondary source is linked to the controller to ensure a constant value to the converter. The conversion of mechanical energy into electrical power is the main mechanism by which the bicycle dynamo produces power. The primary supply source for this arrangement is the 12V-10W solar panel. An indicator circuit with embedded LEDs is used to detect the irradiation level of the solar panel. The modified Multi-Input SEPIC converter is placed between the sources and the load (a spotlight). The function of the potentiometer in the above scenario is to regulate the converter's duty cycle and the Arduino board delivers the duty cycle for the switching element (MOSFET) of the converter.

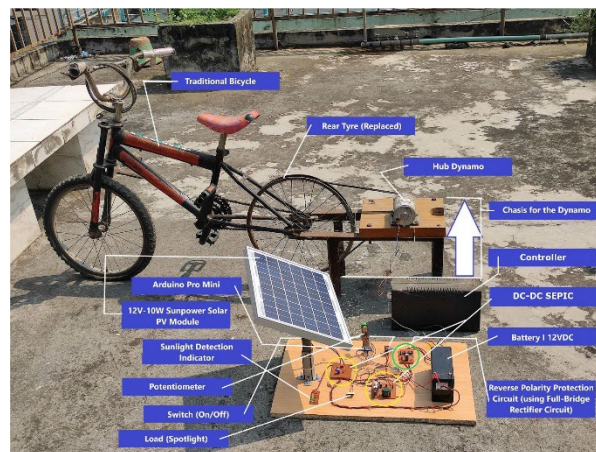

Fig. 3. Field-Test Prototype of the Proposed System.

2.2. Reverse Voltage Polarity Protection Circuit

During the implementation of the hybrid RES using the MIC, a Reverse Voltage Polarity Protection Circuit is used, which can also be called a safety-protection circuit. This safety protection circuit is built using four diodes of the IN4007 model to safeguard from the reverse polarity issue from the secondary source of the bicycle dynamo. This circuit will work as a rectifier and the main benefit of designing this circuit is that it will rectify the bicycle dynamo output voltage's reverse polarity. Fig. 4 and Fig. 5 present the conceptual and actual circuit that is used in this project respectively.

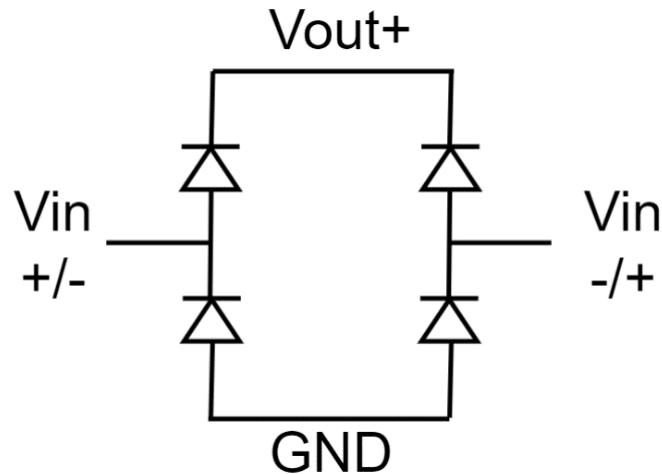

Fig. 4. Conceptual Circuit Model of the Reverse Polarity Protection System

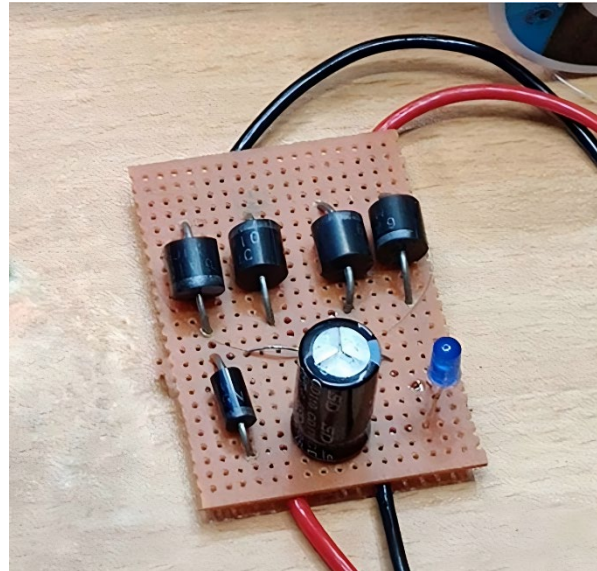

Fig. 5. Circuit of the Reverse Polarity Protection System in the Prototype

2.3. Conventional Single Input SEPIC Converter

In terms of performance, the comparison between the Multi-Input SEPIC converter and the Single-Input SEPIC converter, a conventional DC-DC SEPIC converter is also built. Hardware implementation and performance analysis give a clear view of the advantages of Multi-Input converters over single-input. Fig. 6 illustrates the Single-Input SEPIC converter prototype of this project.

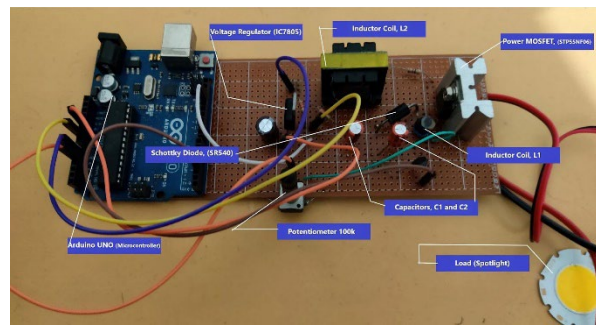

Fig. 6. Field-Test Prototype of the Single-Input SEPIC Converter.

The purpose of the Arduino board in this circuit is to produce a duty cycle that will be passed to the MOSFET for switching. A potentiometer is also used in the board to control the duty cycle generated by the microcontroller circuit. First, a SEPIC-based Single-Input topology is developed to understand the effectiveness of the SEPIC topology better. Afterward, the outcome is contrasted with that of the Multi-Input configuration. Later on, the hybrid RES, solar panel, and bi-cycle dynamo are added to the Multi-Input Converter (MIC) topology.

2.4. Key Components for Designing the Converter Circuits

In this project, both single and multiple input topologies of the DC-DC SEPIC converters have been built for comparative analysis. Elements used in the converter can influence the efficiency by many times. Table 1 presents the elements list that is used in the converter circuits [1].

Table 1. Converter Components List.

Components	Single-Input SEPIC Converter	Multi-Input SEPIC Converter
Switching MOSFET	STP55NF06	N Channel, 60V, 0.01 Ω , 50A to 220/To-220 Fp
Inductor	L_1 = Handmade Iron Core Coil, L_2 = Ferric-Core/Double E-core Flyback	$L_1 = L_2$ (Handmade Iron Core Coil); $L =$ Ferric-Core/Double E-core Flyback
Capacitor	$C_1 = C_2$ (Electrolytic Capacitor)	$C_1 = C_2, C$ (Electrolytic Capacitor)
Microcontroller	Arduino UNO	Arduino Pro Mini
Diode	SR540	Schottky Diode ZRB582
Battery	---	Lead Acid, 12 V 7.5 Ah
Source	AC220V-to-DC12V 2A Switching Power Supply module	Solar Photovoltaic Module & Bicycle Dynamo

During the implementation of the hardware segments, the inductors L_1 and L_2 are used as handmade coil elements. For a better comparison, for both of the converters' designs, the same uniform voltage of 12.1 is used. For the duty cycle generator, Arduino ProMini is used with a generating frequency of 32000 Hz. This duty cycle switches the MOSFET for both of the topologies. In the suggested system, a 3 Amp Schottky diode has been included, along with two MOSFETs, and an N-P-N transistor. The N-P-N transistor functioned as the gate GDC (Gate Driver Circuit). Furthermore, this circuit makes use of big coils to control the ripple effect.

3. BRIEF OVERVIEW OF THE SINGLE-INPUT AND MULTI-INPUT SEPIC CONVERTERS OF THE SYSTEM

Voltage converters of the DC-DC form are widely employed in plenty of fields [14]. DC-DC converter circuits are highly used due to the low input voltage from the renewables and to accommodate the widely variable load demand. The most popular converter topologies are the Buck, Boost, Buck-Boost, Cuk, and SEPIC converters [34]. Among the topologies, SEPIC offers an output voltage lower, the same, or higher than the input ones. The duty cycle of the control transistor mainly regulates the output voltage of the SEPIC i.e., MOSFET [35].

3.1. Single-Input SEPIC Converter

Conventional Single-Input SEPIC converters can only have a single voltage source connected to the input terminal. To compare with the modified Multi-Input SEPIC converter in this project, a standard SEPIC converter is also constructed and examined. Fig. 7 shows the conventional SEPIC converter circuit diagram with a single input source.

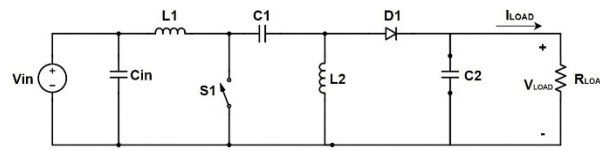

Fig. 7. Conventional Single-Input SEPIC Converter [36]

To convert voltage and current the above-shown SEPIC topology operates similarly to the other converter topologies by swapping energy among the capacitors and inductors continuously. Switching circuits i.e., MOSFET control the power and energy flow in the topology. The converter must be in a Continuous Conduction Mode (CCM), where the current through the inductors never drops to nil, to ensure voltage gain. For that, the values of the inductor must be set accordingly. The converter has two operational modes such as S_1 is opened and S_1 is closed. When switch S_1 is opened, the source voltage starts to charge the C_1 capacitor through L_1 . The diode D is activated as a result of the inductor L_2 changing polarity to resist the change in the current direction. The inductor L_2 discharges via the output capacitor as well as through the load. At the time, when S_1 is closed, the path through the switch is shorted. The L_1 is charged by the source voltage and C_1 is discharged through inductor L_2 . The following equations can be utilized to design the Single-Input SEPIC converter by finding the appropriate parameters [36].

$$\text{Duty Cycle, } D = \frac{V_o}{V_o + V_{in}} \quad (1)$$

$$\text{Inductor, } L = \frac{V_o D}{f \Delta i L_1} \quad (2)$$

$$\text{Capacitor, } C = \frac{V_o D}{R f \left(\frac{\Delta V C_1}{V_o} \right)} \quad (3)$$

Here, for this project, both the inductors and the capacitors are kept equal for designing the Single-Input SEPIC converter. V_o and V_{in} stand for output voltage and input voltage respectively. f stands for the switching frequency of the MOSFET and R denotes the load resistor. iL_1 and VC_1 mean the ripple current through the inductor and output ripple voltage respectively.

3.2. Multi-Input SEPIC Converter

A streamlined circuit architecture of the suggested topology is displayed in Fig. 8. The following circuit can take n number of input voltage renewable energy sources and another one is for an energy storage device to store power generated by the RES. The suggested design configuration has the capability of increasing or decreasing the number of input ports even further by connecting or detaching the sources. Essentially, a Multi-Input converter circuit topology combines several voltage sources in the input terminal with different levels of voltage and transmits a single output voltage to the loads connected to the output port [37].

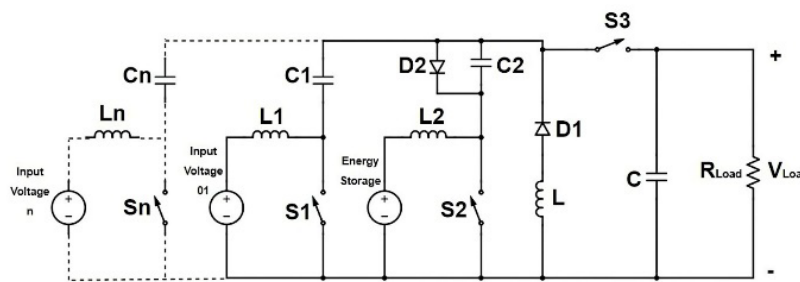

Fig. 8. Streamlined Diagram of Multi-Input SEPIC Converter [19]

Primarily, it works in both directions as the DC-DC converter enables the batteries to be charged by the RES and also it can be discharged when the RES cannot generate enough power to run the loads. The converter can be operated in two modes such as when the RES generates enough power and charges the batteries and when the RES option is not available allowing the batteries to discharge. The converter will only operate in a single direction if the battery voltage is higher than the voltage produced by the RES. In this case, the following is the equation of the relationship between the output voltage and duty cycle,

$$V_o = \frac{D_2 E + (D_1 - D_2) V_1}{1 - D_1} \quad (4)$$

On the other hand, when the sources generate enough voltage, it will simultaneously supply to the loads and charge the energy storage device which will enable the converter to work as bi-directional. Here, the relationship between the output voltage and duty cycle is,

$$V_o = \frac{D_1 V_1 + (1 - D_1)(V_1 - E)}{1 - D_1} \quad (5)$$

Here, the duty cycle of switches 1 and 2 is denoted by D_1 and D_2 respectively. V_1 stands for RES and E is the energy storage device. In this project, duty cycles are set to ensure the boost mode operation of the modified DC-DC converter. Moreover, the shape of the input inductors and capacitors as well as the size of the output LC filter considered to be the crucial design factors for this circuit modeling.

4. SOFTWARE SIMULATION

The feasibility and practicability of the system are ascertained by the Simulink software. In simulation software, a comparable Simulink model can represent the real system. As it is known that, in real-case scenarios, temperature and irradiation from the sun don't remain constant and so, variable data of temperature and irradiation are given into the PV module during the software simulation. The abovementioned variable data are collected from SWERA and for worst-case scenarios, data from winter is taken into consideration during simulation since during winter we get less energy from the Sun [33]. These (SWERA) data represent the annual average daily solar irradiation of Bangladesh. Fig. 9 depicts the proposed system in the MATLAB/Simulink software environment.

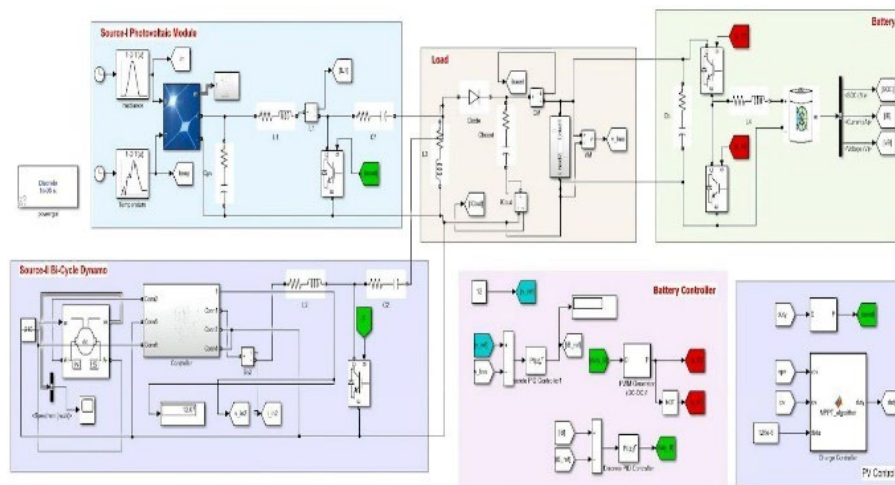

Fig. 9. Suggested Design in MATLAB/Simulink Software.

A modified Multi-Input SEPIC converter in the above diagram is presented in Simulink for practicability checking. The two sources connected to the converter are the photovoltaic module and the bi-cycle dynamo. The bi-cycle dynamo of the real system is replaced by a comparable DC machine here for the simulation purpose along with a controller circuit for stable output from the dynamo. The speed of the DC machine is input as rad/s unit. The outputs of the two sources are then passed to the load through the modified SEPIC converter. A storage device or battery is placed for the time when both of the input sources will be out of operation. The battery controller circuit in this simulation maintains

and controls the charging and discharging phenomena of the storage element. As mentioned earlier, variable irradiance and temperature values are fed into the solar module based on SWERA data for the winter season as Bangladesh receives the lowest solar energy at that particular time every year. Fig. 10 and Fig. 11 display the varying irradiance and temperature values during simulation respectively.

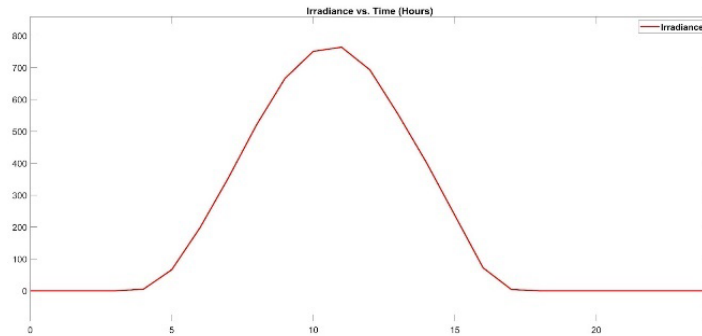

Fig. 9. Varying Solar Irradiance Values During Simulation (Hours in 24 Format)

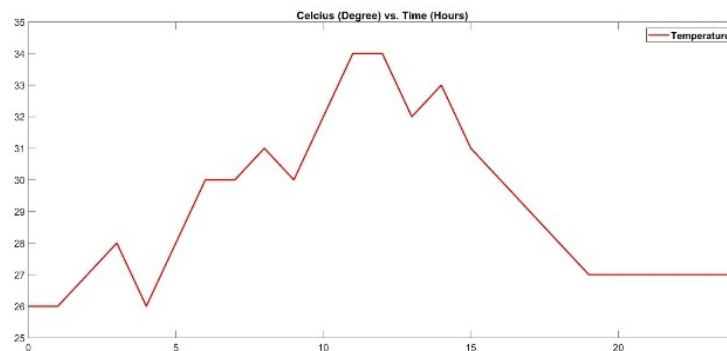

Fig. 11. Varying Temperature Values During Simulation (Hours in 24 Format)

5. RESULTS AND FINDINGS

In this project, the result analysis part is totally segmented into two portions. The first part stands for the study of the software results, and the second part is for the analysis of the results obtained from the hardware prototype. Software analysis is done on the results obtained from MATLAB/Simulink. The hardware analysis part shows a comparative study based on the operability assessment of the Multi-Input and Single-Input DC-DC SEPIC converter.

5.1. Software Result Analysis

As a part of this project, the Multi-Input SEPIC converter's functionality is assessed using MATLAB/Simulink software to examine the system's feasibility. This section describes the findings of the simulation of the Multi-Input SEPIC converter. Table 2 exhibits the values of the components and key parameters during the design of the converter in the software [1].

Table 2. Software Simulation Parameters of the Multi-Input SEPIC Converter.

Parameters	Values
L_1	336 μ H
L_2	100 μ H
C_1	504 μ F
C_2	100 μ F
C	504 μ F
L	336 μ H
Load	25 Ω
Switching Frequency	32 kHz

Software analysis is conducted for the winter season as a worst-case scenario. Usually, in winter, solar irradiance is much lesser compared to the summer season since Bangladesh receives less amount of solar energy in the winter season, especially in the months of December and January. So, the PV module will generate reduced power in that time. The simulation is performed based on small-scale applications to check the feasibility of implementing them on a large scale. Fig. 12 elucidates the output voltage and power of the photovoltaic module that is used in the simulation.

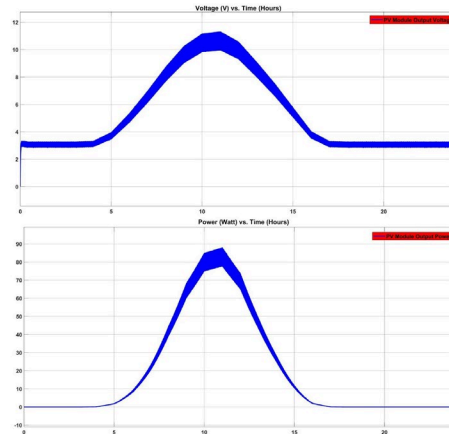

Fig. 12. PV Module Output Voltage and Power (Hours in 24 Format).

Due to the daily variable solar radiation and temperature data given to the photovoltaic utilizing SWERA, the output voltage also varies according to that. During the winter the sun sets early in this part of the world and so, the solar panel gives a significant amount of voltage at noon. Otherwise, it gives a negligible amount of voltage. The output power graph of the photovoltaic module also follows the footsteps of the previous voltage graph. During the sun hour, it generates power and apart from that time, the output power becomes almost zero. At the peak hour, output power almost reaches 87 Watts from the solar panels. Fig. 13 refers to the output voltage and power from the bi-cycle dynamo.

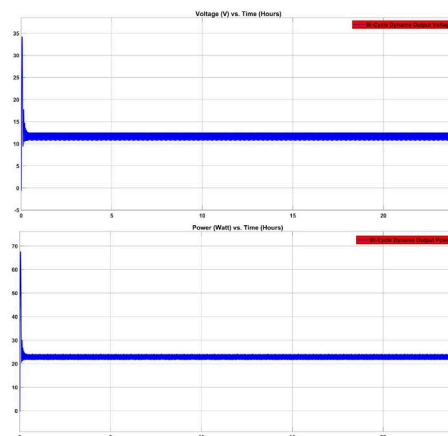

Fig. 13. Bi-cycle Dynamo Output Voltage and Power (Hours in 24 Format).

The output voltage and power generated by the bi-cycle dynamo are independent of time and weather which means the output parameters are available throughout the day in all weather conditions. The output power from the bi-cycle dynamo remains almost constant throughout the simulation and it fluctuates continuously between 22Watt to 24Watt. Fig. 14 displays the total output voltage from the output terminal of the Multi-Input SEPIC converter.

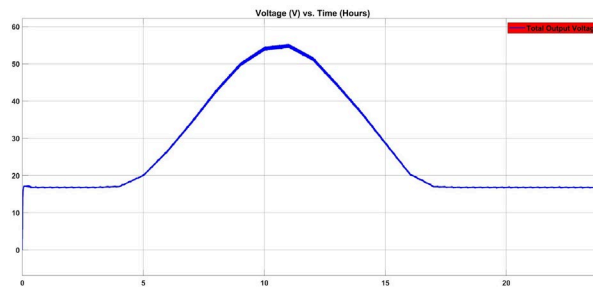

Fig. 14. Total Output Voltage of the Multi-Input DC-DC SEPIC Converter (Hours in 24 Format).

The output voltage is increased to 55V at the output port of the DC-DC converter at the peak of solar irradiance which is approximately 230% higher than the aggregate of the double input voltage sources. During the nighttime, the output voltage from the system remains constant at 18V almost. The total output power of the Multi-Input converter is demonstrated in Fig. 15.

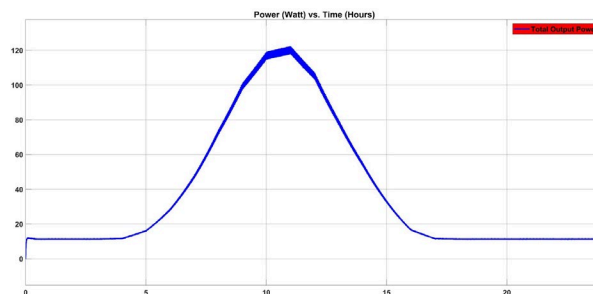

Fig. 15. Total Output Power of the Multi-Input DC-DC SEPIC Converter (Hours in 24 Format).

The total output power from the modified converter reaches 120 Watts approximately at the peak. This power will simultaneously be supplied to the loads and utilized to charge the batteries. When both of the sources are out of order, the energy storage device will be discharged by supplying power to the load terminal.

5.2. Hardware Analysis

In the hardware analysis segment of the project, the Single-Input and Multi-Input SEPIC converters' performance is evaluated. Firstly, the diagram of the relation between voltage gain and duty cycle for both converters' topologies is presented. In this study, the converters are operated in boost mode, so the duty cycle is never set below 50%. Fig. 16 exhibits the gain of the voltage of the converters of this study.

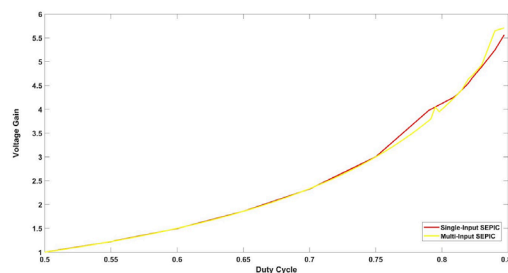

Fig. 16. Voltage Gain of the Converters Varies with Duty Cycle.

The accompanying figure demonstrates that the Multi-Input converter exhibits a higher voltage gain at higher duty cycle levels ($0.8 <$). At the peak, the Multi-Input converter shows a voltage gain of 5.6 when the duty cycle is set to 85%. In fact, for both of the converters, voltage gain increases exponentially. The efficiency and duty cycle of the proposed converters have been illustrated in Fig. 17.

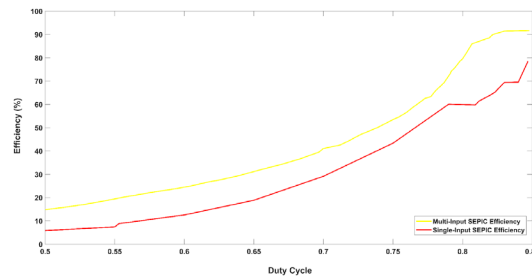

Fig. 17. Efficiency of the Converters with Duty Cycle

In terms of efficiency, the Multi-Input converter outplays the Single-Input converter by a great margin. For each of the adjusted duty cycles, the Multi-Input converter shows greater efficiency. This converter manifests an efficiency of 91.6% approximately while the duty cycle is set to nearly 85%. However, the Single-Input converter performs poorly compared to the Multi-Input one. One of the reasons behind having the higher efficiency rate for the multi-input converter is, that the components used in designing the multi-input converter for the same performance that can be achievable by multiple single-input converter is lower. And, a lower number of components means that the heat dissipation is also reduced. So, making a system with more than one renewable energy source with multiple single-input converters will cost more in terms of both financial and efficiency.

6. CONCLUSION

This literature suggests a modified Multi-Input DC-DC SEPIC converter and both software simulation and hardware analysis have been utilized to extensively evaluate how the suggested converter functions. For hardware and software analysis, a PV module and bi-cycle dynamo are used as the power sources for the modified DC-DC SEPIC converter. This study also determines the characteristics and features of hybrid renewable energy sources (RES) integrated through a single piece of converter topology. By comparing the performance with the conventional Single-Input DC-DC converter, therefore safe to say that the proposed Multi-Input converter shows better performance to integrating multiple energy sources with better efficiency and performance results. By evaluating and verifying the actual findings, it can be confirmed that the theoretical analyses, design concepts, and specific processes are accurate. The advantages of the suggested topology make it a suitable converter for systems that produce power from clean energy sources. Due to the perfect geographical position to utilize solar power efficiently and considering the fact of energy security for the poor rural people of the country, this project can be proven to be a savior. The implementation of this converter along with the hybridization of renewable energy sources can offer a sustainable solution for people living in off-grid areas. Hybridization of renewable energy sources allows for reducing dependency on the highly stochastic nature of the sources and by adopting the Multi-Input DC-DC SEPIC converter, efficient energy supply to the loads can be ensured.

7. ACKNOWLEDGEMENT

We sincerely appreciate the insightful advice and kind assistance provided by the Department of Electrical and Electronic Engineering at BRAC University, which helped us carry out the project successfully.

Data Availability. Data underlying the results presented in this paper are available from the corresponding author upon reasonable request.

Funding. There is no funding for this work.

Conflicts of interest. The authors declare no conflict of interest.

Ethics. The authors declare that the present research work has fulfilled all relevant ethical guidelines required by COPE.



This article is licensed under a Creative Commons Attribution 4.0 International License.

©The Author(s) 2024

REFERENCE

- [1] T. Mahmud, S. M. A. Rakeen, A. U. Araf, N. Ahmed and A. K. M. Abdul Malek Azad, "Design and Accuracy Assessment of a Multi-Input Single Ended Primary Inductor Converter (SEPIC) for Highly Efficient Output from Hybrid Sources of Renewable Energy," 2022 IEEE International Systems Conference (SysCon), Montreal, QC, Canada, 2022, pp. 1-8, doi: 10.1109/SysCon53536.2022.9773908.
- [2] S. Hossain and M. M. Rahman, "Solar Energy Prospects in Bangladesh: Target and Current Status", Energy and Power Engineering, Vol.13 No.8, 2021. Available: 10.4236/epe.2021.138022
- [3] "RE Generation Mix | National Database of Renewable Energy", Renewableenergy.gov.bd, 2021. [Online]. Available: <http://www.renewableenergy.gov.bd/index.php?id=4>. [Accessed:04- Sep-2023]
- [4] A. Maimó-Far, A. Tantet, V. Homar, and P. Drobinski, "Predictable and Unpredictable Climate Variability Impacts on Optimal Renewable Energy Mixes: The Example of Spain," Energies, vol. 13, no. 19, p. 5132, Oct. 2020, doi: 10.3390/en13195132.
- [5] M. W. Mustafa, G. Anandhakumar, A. M. Jacob, N. B. Singh, S. Asha, and S. A. Jayadhas, "Hybrid Renewable Power Generation for Modeling and Controlling the Battery Storage Photovoltaic System," International Journal of Photoenergy, vol. 2022, pp. 1–12, Feb. 2022, doi: 10.1155/2022/9491808.
- [6] Megalingam, Rajesh Kannan & Sreedharan Veliyara, Pranav & Prabhu, Raghavendra & Katoch, Rocky. (2012). Pedal Power Generation. 7.
- [7] H. Ardi and A. Ajami, "Study on a High Voltage Gain SEPIC-Based DC–DC Converter with Continuous Input Current for Sustainable Energy Applications", IEEE Transactions on Power Electronics, vol. 33, no. 12, pp. 10403-10409, 2018. Available: 10.1109/tpel.2018.2811123.
- [8] R. Ebrahimi, H. Madadi Kojabadi, and L. Chang, "Application of DC-DC Converters at Renewable Energy," Nanogenerators and Self-Powered Systems [Working Title], Dec. 2022, doi: 10.5772/intechopen.108210.
- [9] M. Banaei, H. Ardi, R. Alizadeh and A. Farakhor, "Non-isolated multi-input–single-output DC/DC converter for photovoltaic power generation systems", IET Power Electronics, vol. 7, no. 11, pp. 2806-2816, 2014. Available: 10.1049/iet-pel.2013.0977.
- [10] I. Jagadeesh and V. Indragandhi, "Comparative Study of DC-DC Converters for Solar PV with Microgrid Applications," Energies, vol. 15, no. 20, p. 7569, Oct. 2022, doi: 10.3390/en15207569.
- [11] W. Li, X. Lv, Y. Deng, J. Liu and X. He, "A Review of Non-Isolated High Step-Up DC/DC Converters in Renewable Energy Applications," 2009 Twenty-Fourth Annual IEEE Applied Power Electronics Conference and Exposition, Washington, DC, USA, 2009, pp. 364-369, doi: 10.1109/APEC.2009.4802683.
- [12] Y. Hsieh, J. Chen, T. Liang and L. Yang, "Novel High Step-Up DC–DC Converter with Coupled-Inductor and Switched-Capacitor Techniques", IEEE Transactions on Industrial Electronics, vol. 59, no. 2, pp. 998-1007, 2012. Available: 10.1109/tie.2011.2151828.
- [13] R. M. Madhana and M. Geetha, "Power enhancement methods of renewable energy resources using multiport DC-DC converter: A technical review," Sustainable Computing: Informatics and Systems, vol. 35, p. 100689, Feb. 2022, doi: 10.1016/j.suscom.2022.100689.
- [14] R. Moradpour, H. Ardi and A. Tavakoli, "Design and Implementation of a New SEPIC-Based High Step-Up DC/DC Converter for Renewable Energy Applications", IEEE Transactions on Industrial Electronics, vol. 65, no. 2, pp. 1290-1297, 2018. Available: 10.1109/tie.2017.2733421.
- [15] M. Dhananjaya and S. Pattnaik, "Design and Implementation of a Multi-Input Single-Output DC-DC Converter," 2019 IEEE International Conference on Sustainable Energy Technologies and Systems (ICSETS), Bhubaneswar, India, 2019, pp. 194-199, doi: 10.1109/ICSETS.2019.8744815.
- [16] S. Haghhighian, S. Tohidi, M. Feyzi and M. Sabahi, "Design and analysis of a novel SEPICbased multi-input DC/DC converter", IET Power Electronics, vol. 10, no. 12, pp. 1393-1402, 2017. Available: 10.1049/iet-pel.2016.0654.
- [17] R. W. Erickson and D. Maksimovic, Fundamentals of Power Electronics. Springer Science & Business Media, 2007.
- [18] P. K. Maroti, S. Smaeili, A. Iqbal, and M. Meraj, "High step-up single switch quadratic modified SEPIC converter for DC microgrid applications," Iet Power Electronics, vol. 13, no. 16, pp. 3717–3726, Dec. 2020, doi: 10.1049/iet-pel.2020.0147.
- [19] C. Anuradha, N. Chellammal, M. Saquib Maqsood and S. Vijayalakshmi, "Design and Analysis of Non-Isolated Three-Port SEPIC Converter for Integrating Renewable Energy Sources", Energies, vol. 12, no. 2, p. 221, 2019. Available: 10.3390/en12020221.
- [20] R. Zhao and A. Kwasinski, "Multiple-input single ended primary inductor converter (SEPIC) converter for distributed generation applications," 2009 IEEE Energy Conversion Congress and Exposition, San Jose, CA, USA, 2009, pp. 1847-1854, doi: 10.1109/ECCE.2009.5316295.
- [21] D. M. Sangalad, Hemalatha J N, Hariprasad S.A. and Anitha G.S., "Design and analysis of dual input SEPIC converter for renewable energy sources," 2015 International Conference on Emerging Research in Electronics, Computer Science and Technology (ICERECT), Mandya, India, 2015, pp. 358-363, doi: 10.1109/ERECT.2015.7499041.
- [22] G. Mohanty, "SEPIC Based Multi Input Dc-Dc Converter," 2019 IEEE 5th International Conference for Convergence in Technology (I2CT), Bombay, India, 2019, pp. 1-4, doi: 10.1109/I2CT45611.2019.9033886.
- [23] Z. Rehman, I. Al-Bahadly, and S. C. Mukhopadhyay, "Multiinput DC–DC converters in renewable energy applications – An overview," Renewable & Sustainable Energy Reviews, vol. 41, pp. 521–539, Jan. 2015, doi: 10.1016/j.rser.2014.08.033.

- [24] A. Khaligh, J. Cao and Y. -J. Lee, "A Multiple-Input DC–DC Converter Topology," in IEEE Transactions on Power Electronics, vol. 24, no. 3, pp. 862-868, March 2009, doi: 10.1109/TPEL.2008.2009308.
- [25] H. Wu, J. Zhang and Y. Xing, "A Family of Multiport Buck–Boost Converters Based on DC-Link-Inductors (DLIs)," in IEEE Transactions on Power Electronics, vol. 30, no. 2, pp. 735-746, Feb. 2015, doi: 10.1109/TPEL.2014.2307883.
- [26] C. Wang and M. H. Nehrir, "Power Management of a Stand-Alone Wind/Photovoltaic/Fuel Cell Energy System," in IEEE Transactions on Energy Conversion, vol. 23, no. 3, pp. 957-967, Sept. 2008, doi: 10.1109/TEC.2007.914200.
- [27] P. Patra, A. Patra and N. Misra, "A Single-Inductor Multiple-Output Switcher with Simultaneous Buck, Boost, and Inverted Outputs," in IEEE Transactions on Power Electronics, vol. 27, no. 4, pp. 1936-1951, April 2012, doi: 10.1109/TPEL.2011.2169813.
- [28] P. Saritha, V. Devi, A. Babu, and R. P. Praveen, "Design and analysis of multiple input single output converter for hybrid renewable energy system with energy storage capability," Ain Shams Engineering Journal, p. 102194, Feb. 2023, doi: 10.1016/j.asej.2023.102194.
- [29] A. M.-T. Al-Modaffer, A. A. Chlahawi, and H. A. Wahhab, "Non-isolated multiple input multilevel output DC-DC converter for hybrid power system," Indonesian Journal of Electrical Engineering and Computer Science, vol. 19, no. 2, p. 635, Aug. 2020, doi: 10.11591/ijeecs.v19.i2.pp635-643.
- [30] M. A. Rosli, N. Z. Yahaya and Z. Baharudin, "Multi-input DC-DC converter for hybrid renewable energy generation system," 2014 IEEE Conference on Energy Conversion (CENCON), Johor Bahru, Malaysia, 2014, pp. 283-286, doi: 10.1109/CENCON.2014.6967516.
- [31] S. Moury, J. Lam, V. Srivastava and R. Church, "A novel multi-input converter using soft-switched single-switch input modules with integrated power factor correction capability for hybrid renewable energy systems," 2016 IEEE Applied Power Electronics Conference and Exposition (APEC), Long Beach, CA, USA, 2016, pp. 786-793, doi: 10.1109/APEC.2016.7467961.
- [32] A. Deihimi, M. E. S. Mahmoodieh, and R. Iravani, "A new multi-input step-up DC–DC converter for hybrid energy systems," Electric Power Systems Research, vol. 149, pp. 111–124, Aug. 2017, doi: 10.1016/j.epsr.2017.04.017.
- [33] M. Hussain, "Final Report of Solar and Wind Energy Resource Assessment (SWERA) - Bangladesh Project," SWERA – Bangladesh group, Dhaka, 2007.
- [34] V. Nath and J. K. Mandal, Proceedings of the Third International Conference on Microelectronics, Computing and Communication Systems: MCCS 2018. Springer, 2019.
- [35] S. K. Haghghian, S. Tohidi, M. R. Feyzi, and M. Sabahi, "Design and analysis of a novel SEPIC-based multi-input DC/DC converter," Iet Power Electronics, vol. 10, no. 12, pp. 1393–1402, Oct. 2017, doi: 10.1049/iet-pel.2016.0654.
- [36] M. Verma and S. S. Kumar, "Hardware Design of SEPIC Converter and its Analysis," 2018 International Conference on Current Trends towards Converging Technologies (ICCTCT), Coimbatore, India, 2018, pp. 1-4, doi: 10.1109/ICCTCT.2018.8551052.
- [37] S. A. Gorji, H. G. Sahebi, M. Movahed and M. Ektesabi, "Multi-Input Boost DC-DC Converter with Continuous Input-Output Current for Renewable Energy Systems," 2019 IEEE 4th International Future Energy Electronics Conference (IFEEC), Singapore, 2019, pp. 1-5, doi: 10.1109/IFEEC47410.2019.9014953.