



Finite-Time Bounded Model-Based Event-Triggered Control for Distributed Fuzzy T-S Systems

Davood Nazari Maryam Abadi¹, Ali Moarefianpour², Nima Mahdian Dehkordi³

1-Department of Mechanics, Electrical and Computer Engineering, Research and Science Branch, Islamic Azad University, Tehran, Iran.

Email: davood.nazari@srbiau.ac.ir

2-Department of Mechanics, Electrical and Computer Engineering, Research and Science Branch, Islamic Azad University, Tehran, Iran.

Email: moarefian@srbiau.ac.ir (Corresponding author) 

3- Control Department of Electrical Engineering, Shahid Rajaei Teacher Training University, Tehran, Iran.
Email: nimamahdian@sru.ac.ir

ABSTRACT:

In this paper, the problem of model-based finite-time bounded event-triggered control for distributed fuzzy T-S systems is presented. For this purpose, the whole network model is embedded locally in both the controller and the remote telemetry unit. In order to estimate the states of the plant between two consecutive events, a fuzzy observer has been used. Model-based state estimation reduces the state error and consequently leads to reduction of data transmission instants. By the network model and event triggering block which are placed locally in each remote telemetry unit, the time of data transmission on the distributed network is determined. Finally, the finite-time boundedness of the closed-loop system has been investigated using MATLAB software for a centralized and a distributed system, respectively.

KEYWORDS: Event-Triggered Control, Finite-Time Bounded, Fuzzy T-S Control, Model-Based Control, Uncertainties.

LIST OF SYMBOLS

h	Remote telemetry unit sample time
Ω_l	Event triggering function gains
σ_l	
k_l^a	Transfer instant of the a th subsystem
L_i^a	Observer gain of the a th subsystem
d_M	Minimum time between events
τ	Transfer delay
N	The time for reaching to finite time boundedness
K	Gain matrix of distributed system

1. INTRODUCTION

The main characteristic of a Takagi and Sugeno (T-S) fuzzy model is the expression of local dynamics of each fuzzy rule by a linear system model. The overall fuzzy system model is obtained by combining the linear system models. Productive results on controller and filter design problems for nonlinear systems via T-S fuzzy model were

©The Author(s) 2024

Paper type: Research paper

<https://doi.org/10.30486/mjee.2023.1994207.1226>

Received: 11 October 2023; revised: 25 November 2023; accepted: 18 December 2023; published: 1 March 2024

How to cite this paper: D. Nazari Maryam Abadi, A. Moarefianpour, and N. Mahdian Dehkordi, "Finite-Time Bounded Model-Based Event-Triggered Control for Distributed Fuzzy T-S Systems", *Majlesi Journal of Electrical Engineering*, Vol. 18, No. 1, pp. 117-136, 2024.

presented in articles [1-10]. For example, in [11], an observer-based exponential stabilization indicator for event-triggered fuzzy systems with observer-based sliding mode fuzzy control was implemented. Event-triggered interval type-2 T-S fuzzy for nonlinear networked systems was presented in [12]. Event-triggered trusted control for a class of uncertain T-S fuzzy nonlinear systems was designed in [13]. Event-triggered controller for T-S fuzzy systems with time-delay has been implemented in [14].

Recently, finite-time stability has been raised in practical processes to prevent saturation and excitation of nonlinear dynamics during the transient response. Unlike Lyapunov stability, which requires the convergence of the equilibrium point in infinite time, in finite time stability, it is only required that the system remains stable at a certain time. Finite-time stability has advantages such as high convergence speed, greater resistance to uncertainty, and better disturbance rejection [15-16]. Since the settling time depends on the initial conditions, finite-time control is forbidden for systems with unattainable initial conditions. In digital control systems, the sampling process is intermittent or time-triggered and the signals in the loop are updated at each sampling moment. However, when the controlled system states reach the equilibrium point, even if there is no disturbance, the sensor measurement signal has little effect on the system performance. In this case, useless sampled data may be generated. Undoubtedly, the transmission data reduces the efficiency of the communication network and leads to unnecessary energy consumption. For this purpose, the event-triggered communication scheme is proposed to overcome the shortcomings of the triggered time control method. This communication scheme can effectively use the bandwidth of the communication network because the transfer of sampled data between the controller and system occurs only when a pre-defined event-triggering condition is met. Therefore, finite-time event-triggered H_∞ fuzzy output feedback controller is designed in [17] for a type of nonlinear system. Finite-time event-triggered controller for nonlinear semi-Markovian switching cyber-physical systems (S-MSCPSs) in the face of false data injection (FDI) attacks was checked in [18]. Event-triggered robust fuzzy adaptive finite-time control is reviewed for a type of strict-feedback nonlinear systems with external disturbances in [19]. Event-based decentralized adaptive fuzzy output-feedback finite-time controller was investigated in [20] for large-scale nonlinear systems. A dynamic event-triggered finite-time controller is provided in [21] for switched T-S Fuzzy systems. The authors in [22] have studied the model-based event-triggered control to check the performance of an underactuated surface vessel (USV). In [23], unknown nonlinear dynamics of nonlinear multi-agent systems are approximated by fuzzy logic systems with the goal of finite-time stability, and in order to increase communication bandwidth dynamic, event-triggered scheme is used. T-S fuzzy is used in [24] to model discrete-time nonlinear Markov jump systems with the control objective of maintaining system states within a predetermined range and at a given time. In order to improve network bandwidth, a mode-dependent event-triggered scheme is constructed. In order to control nonlinear systems with input hysteresis, parametric uncertainty fuzzy adaptive event-triggered finite-time constraint is used in [25]. Input-output finite-time stabilization of interval type-2 fuzzy systems against the effect of deception attack has been reviewed in [26]. Nonlinear systems with unmodeled dynamics, asymmetric time-varying output constraints, and uncertain disturbances have been controlled by finite-time adaptive tracking scheme in [27]. An event triggering scheme in which the threshold is set dynamically has been used to preserve communication resources. In the mentioned articles, the prevention of Zeno behavior has not been proven. In [28], a fuzzy adaptive event-triggered scheme is used in multi-agent systems to satisfy the prescribed performance while avoiding zeno behavior.

In the mentioned articles, system modes are required to be available. For times when system states are not available, the output feedback controllers with appropriate state observers should be designed. For this purpose, in [29], event-triggered control, based on the distributed model is proposed for load frequency regulation in smart grids, and input-state stability (ISS) is proved. It has been also shown that the use of the entire network model in the intervals between two consecutive events leads to a reduction in the state estimation error. In addition, the network model and event trigger block are also placed locally in the sensors to determine the data transfer time on the distributed network. Observer-based finite-time event-triggered fuzzy fault-tolerant controller is used in [30] for the interval type-2 (IT2) Takagi-Sugeno fuzzy system with parameter uncertainties and actuator faults. An observer-based finite-time event-triggered H_∞ fuzzy controller is designed in [31] for a class of nonlinear systems.

Most of the existing works deal with T-S fuzzy systems have the following limitations or disadvantages: First, it is assumed that all states of the system are measurable, therefore output feedback control problems cannot be solved. Second, the designed controllers are time-triggered instead of using event-triggered schemes, so they are not able to increase the network bandwidth.

To the best of the authors' knowledge, the finite-time bounded fuzzy model-based event-triggered control has not been addressed for distributed T-S fuzzy systems with immeasurable states, which motivates this study. By the proposed method, in the intervals between two consecutive events, the event trigger engine determines the time to send information to neighboring subsystems by comparing the states obtained in the corresponding subsystem and the states of the fuzzy model of the entire system. When the information transmission happens, the remote measurement

unit partially updates the fuzzy model of the whole network by receiving the states of the neighboring subsystems. So, compared to [17], in which the dynamic event triggering scheme is used, the bandwidth is increased. In comparison with [29], where in distributed model-based event-triggered controller is used, the number of samples has further reduced. The proposed fuzzy model-based event-triggered controller compared to fuzzy time-based event-triggered controller in [32] has better tracking while fewer events are triggered.

The main contribution of the paper is as follows:

- 1- The model-based event-triggered is first introduced for distributed T-S fuzzy systems, which can reduce more computation and communication resources than the traditional static event-triggered mechanism while the boundedness of the closed-loop system and the existence of minimum inter-event time are guaranteed.
- 2- By developing the model-based event-triggered scheme, the finite-time bounded performance criteria are deduced for distributed T-S fuzzy systems while the transmission delay is considered. It should be noted that the transmission delay makes it impossible to prove the finite time boundedness by ordinary Lyapunov functional and the Lyapunov-Krasovskii functional should be used.
- 3- Considering the superiority of model-based event-triggered scheme over event-triggered schemes with static and dynamic threshold, in this paper, model-based event-triggered scheme is used for T-S fuzzy systems.
- 4- Assuming that all states are not measurable, the state estimator has been designed. So the output feedback control problem can be solved on the T-S fuzzy systems with immeasurable states.

The rest of the paper is organized as follows: section 2 states mathematical prerequisites and used lemmas. Section 3 illustrates the basic concepts of model-based finite-time bounded event-triggered control for distributed fuzzy T-S systems. In section 4 finite-time boundlessness and the condition of minimum time between events for the proposed controller are proven. Simulation results are presented in section 5 and finally, the conclusion is expressed in section 6.

2. PRELIMINARIES

Lemma 1: [33] Consider matrices Y, E, J with appropriate dimensions where Y is a symmetric matrix. The $Y + EFJ + (EFJ)^T < 0$

holds for all matrix F satisfying $FF^T < I$, if and only if there exists a constants $\varepsilon > 0$, such that $Y + \varepsilon EE^T + \varepsilon^{-1}J^TJ < 0$ holds.

Lemma 2: (schur complement) [34] Consider the following nonlinear matrix inequalities

$$R > 0 + Q - SR^{-1}S^T > 0$$

where $Q = Q^T, R = R^T$. Based on schur complement, the above inequalities are equivalent to the following Linear Matrix inequality (LMI).

$$\begin{bmatrix} Q & S \\ S^T & R \end{bmatrix} > 0$$

Lemma 3: [35] There are real matrices W, E, J, M such that $S > 0$ and $F^TF \leq I$. Then for any constant $\varepsilon > 0$ such that $S - \varepsilon EE^T > 0$, the following inequality holds.

$$(W + EFJ)^T M^T (W + EFJ) \leq W^T (S - \varepsilon EE^T)^{-1} W + \varepsilon^{-1} J^T J$$

Lemma 4: [35] For matrices and integers $\{a, b, k \in \mathbb{Z}^+\}$ such that $a \leq b \leq k$, there is the vector function $y(i) \rightarrow x(i+1) - x(i), x(i): [k-b, k-a] \cap \mathbb{Z} \rightarrow \mathbb{R}^n$

It can be shown that

$$\chi(k, a, b) = \begin{cases} \frac{1}{b-a} \left[2 \sum_{i=k-b}^{k-a-1} x(i) + x(k-a) - x(k-b) \right] & a < b \\ 2x(k-a) & a = b \end{cases}$$

Then it can be obtained that

$$-(b-a) \sum_{i=k-b}^{k-a-1} y^T(i) X y(i) \leq -[x(k-a) - x(k-b)]^T X [x(k-a) - x(k-b)] - 3\Omega^T z \Omega$$

where $\Omega = x(k-a) + x(k-b) - \chi(k, a, b)$

Definition 1: For constants ϖ and N , the time-varying disturbance input ϖ satisfies the following condition

$$\sum_{k=0}^N \omega^T(k)\omega(k) \leq \varpi$$

Notations:

\mathbb{R}^n denotes the n-dimensional Euclidean space. For symmetric matrices M , $M > 0$ ($M \geq 0$) means that the matrices are positive definite (semi-positive definite). $\lambda_{\min}(P)$ ($\lambda_{\max}(P)$) represents the minimum (maximum) eigenvalues of symmetric matrices P . 0 and I represent the zero matrix and identity matrix, respectively. Transpose of matrix M , is shown with M^T . $\|\cdot\|$ stands for the Euclidean norm. \mathbb{Z}^+ represents the set of nonnegative integers.

3. PROBLEM FORMULATION

In Fig. 1, a distributed network which consists of 4 subsystems is shown. Each subsystem is controlled locally, while due to the interconnection between them, each one should be aware of the states of other ones. However, the continuous transmission of information between subsystems reduces the bandwidth and wastes energy in the communication network. Therefore, model-based event-triggered control has been proposed.

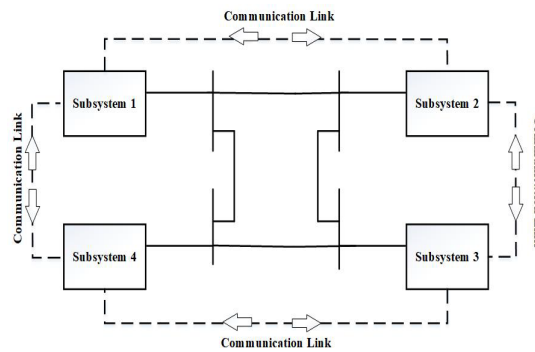

Fig. 1. Configuration of a distributed network.

The overview of the event-triggered fuzzy control for a th subsystem is shown in Fig. 2. Fuzzy system model, event trigger engine, observer, and controller gains are placed in the remote telemetry unit. State measurement in remote telemetry units occurs every h seconds. The event trigger engine determines the time to send information to neighboring subsystems by comparing the states obtained in the corresponding subsystem and the states of the fuzzy model of the entire system. When the information transmission happens, the remote measurement unit partially updates the fuzzy model of the whole network by receiving the states of the neighboring subsystems.

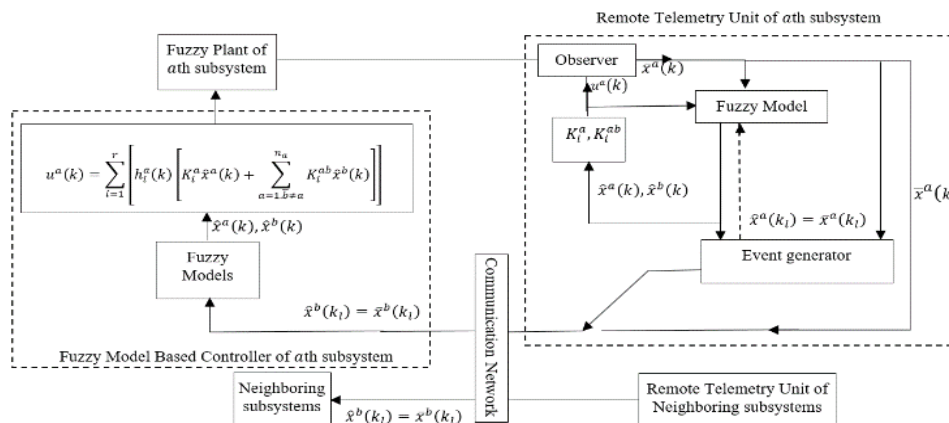

Fig. 2. Event-triggered fuzzy control of the a th subsystem.

3.1. Fuzzy Plant

Consider a fuzzy T-S plant in which the i th rule for the a th subsystem is as follows.

IF $v_1^a(k)$ is $\mu_{i_1}^a$ and \dots and $v_g^a(k)$ is $\mu_{i_g}^a$ THEN

$$\begin{cases} x^a(k+1) = A_i^a x^a(k) + B_i^a u^a(k) + D_i^a \omega(k) \\ z^a(k) = G_i^a x^a(k) + H_i^a u^a(k) + L_i^a \omega(k) \end{cases} \quad (1)$$

where for the a th subsystem, $i = 1, 2, \dots, r$ is the number of if-then rules, $\mu_{ij}^a (i = 1, 2, \dots, r; j = 1, 2, \dots, g)$ and $\vartheta_j^a(k) (j = 1, 2, \dots, g)$ represent fuzzy sets and premise variables respectively. $x^a(k) \in R^{n \times 1}$ is the state vector of the plant and $\omega(k) \in R^{m \times 1}$ is an external disturbance that satisfies Definition 1. $u^a(k) \in R^{m \times 1}$ and $z^a(k) \in R^{p \times 1}$ are control input and controlled output of the plant, respectively. $A_i^a \in R^{n \times n}, B_i^a \in R^{n \times m}, D_i^a \in R^{n \times m}, G_i^a \in R^{p \times n}, H_i^a \in R^{p \times m}, L_i^a \in R^{p \times m} (i = 1, 2, \dots, r)$ are constant known real matrices. The total number of subsystems is equal to n .

The dynamics of fuzzy plant (1) are obtained as follows:

$$\begin{cases} x^a(k+1) = \sum_{i=1}^r h_i^a(\vartheta(k)) [A_i^a x^a(k) + B_i^a u^a(k) + D_i^a \omega(k)] \\ z^a(k) = \sum_{i=1}^r h_i^a(\vartheta(k)) [G_i^a x^a(k) + H_i^a u^a(k) + L_i^a \omega(k)] \end{cases} \quad (2)$$

Where, $h_i^a(\vartheta(k)) = \frac{\prod_{j=1}^g \mu_{ij}^a(\vartheta_j(k))}{\sum_{j=1}^r \prod_{j=1}^g \mu_{ij}^a(\vartheta_j(k))}$ is the fuzzy basis function and $\mu_{ij}^a(\vartheta_j(k))$ represents the membership grade of $\vartheta_j(k)$ in μ_{ij}^a , which satisfies $h_i^a(\vartheta(k)) > 0$ and $\sum_{i=1}^r h_i^a(\vartheta(k)) = 1$.

Definition 2: (Finite-Time Bounded) [17] The Matrix $R > 0$ and the positive constant values c_1, c_2, ϖ and positive integer N are given by the condition $c_1 < c_2$. System (2) with $u(k) \equiv 0$ and Definition 1 is finite-time bounded according to (c_1, c_2, ϖ, N, R) , if $x^T(0)Rx(0) < c_1 \Rightarrow x(k)^T Rx(k) < c_2, \forall k \in \{1, 2, \dots, N\}$

3.2. Fuzzy Model of Interconnected Subsystems

Due to the uncertainty in subsystems model which is caused by imperfect modeling, subsystems matrices are not necessarily equal to model matrices. So the available model of a th subsystem with $a \in \{1, \dots, n\}$ is as follows.

IF $v_1^a(k)$ is $\mu_{i_1}^a$ and \dots and $v_g^a(k)$ is $\mu_{i_g}^a$ THEN

$$\begin{cases} \hat{x}^a(k+1) = \hat{A}_i^a \hat{x}^a(k) + \hat{B}_i^a u^a(k) + \sum_{b=1, b \neq a}^n \hat{A}_i^{ab} \hat{x}^b(k) \\ \hat{z}^a(k) = \hat{C}_i^a \hat{x}^a(k) \\ \hat{x}^a(k+1) = \hat{A}_i^a \hat{x}^a(k) + \hat{B}_i^a u^a(k) + \sum_{b=1, b \neq a}^n \hat{A}_i^{ab} \hat{x}^b(k) \\ \hat{z}^a(k) = \hat{C}_i^a \hat{x}^a(k) \end{cases} \quad (3)$$

Where, $\hat{x}^a(k) \in R^{n \times 1}$ is the model state of a th subsystem and $\hat{x}^b(k) \in R^{n \times 1}$ is the state of the neighboring subsystem b , and n_a and n_b represent the total number of neighbor subsystems of a th and b th control subsystem. Matrices $\hat{A}_i^a \in R^{n \times n}, \hat{A}_i^{ab} \in R^{n \times n}, \hat{B}_i^a \in R^{n \times m}, \hat{C}_i^a \in R^{p \times n}$ are constant known real matrices. $i = 1, 2, \dots, r$ is the number of if-then rules. $\mu_{ij}^a (i = 1, 2, \dots, r; j = 1, 2, \dots, g)$ and $\vartheta_j^a(k) (j = 1, 2, \dots, g)$ represent fuzzy sets and premise variables, respectively. $u^a(k) \in R^{m \times 1}$ is control input and $\hat{z}^a(k) \in R^{q \times 1}$ is the output.

The dynamics of model (3) are obtained as follows

$$\begin{aligned}\hat{x}^a(k+1) &= \sum_{i=1}^r h_i^a(\vartheta(k)) \left[\hat{A}_i^a \hat{x}^a(k) + \hat{B}_i^a u^a(k) + \sum_{b=1, b \neq a}^n \hat{A}_i^{ab} \hat{x}^b(k) \right] \\ \hat{z}^a(k) &= \sum_{i=1}^r h_i^a(\vartheta(k)) [\hat{G}_i^a \hat{x}^a(k)]\end{aligned}\quad (4)$$

Where $h_i^a(\vartheta(k)) = \frac{\prod_{j=1}^g \mu_{ij}^a(\vartheta_j(k))}{\sum_{j=1}^r \prod_{j=1}^g \mu_{ij}^a(\vartheta_j(k))}$ is the fuzzy basis function and $\mu_{ij}^a(\vartheta_j(k))$ is defined as the membership degree of $\vartheta_j(k)$ in μ_{ij}^a .

3.3. Fuzzy Observer

In the implementation of distributed networks due to the multiplicity of system states, sometimes only a part of states is measured and other states are estimated by observer in remote telemetry units [29].

The decentralized state observer in the remote telemetry unit of the a th subsystem can be described in the following form:

IF $\vartheta_1^a(k)$ is $\mu_{i_1}^a$ and \dots and $\vartheta_g^a(k)$ is $\mu_{i_g}^a$ THEN

$$\bar{x}^a(k+1) = A_i^a \bar{x}^a(k) + B_i^a u^a(k) + L_i^a (z^a(k) - G_i^a \bar{x}^a(k))\quad (5)$$

Where for the a th subsystem, $i = 1, 2, \dots, r$ is the number of if-then rules, $\mu_{ij}^a (i = 1, 2, \dots, r; j = 1, 2, \dots, g)$ and $\vartheta_j^a(k) (j = 1, 2, \dots, g)$ represent fuzzy sets and premise variables, respectively. $\bar{x}^a(k) \in R^{n \times 1}$ is the observed state vector of a th subsystem and $L_i^a \in R^{n \times p} (i = 1, 2, \dots, r)$ is the observer matrix gains.

The dynamic model of (5) is

$$\bar{x}^a(k+1) = \sum_{i=1}^r A_i^a \bar{x}^a(k) + B_i^a u^a(k) + L_i^a (z^a(k) - G_i^a \bar{x}^a(k))\quad (6)$$

3.4. Model-Based Event-Triggered

In this scheme, the remote measurement unit plays a different role. In the remote telemetry unit of the a th subsystem, a fuzzy model of all neighboring subsystems and controller gain is embedded. The remote telemetry unit of each subsystem periodically calculates the error between the model state and the estimated state obtained by the observer which is defined according to the following equation.

$$e^a(k) = \hat{x}^a(k) - \bar{x}^a(k_t)\quad (7)$$

Where $\bar{x}^a = [(\bar{x}^1)^T \ (\bar{x}^2)^T \ \dots \ (\bar{x}^n)^T]^T$ is the observed state vector at the last moment of data transfer, $\hat{x}^a = [(\hat{x}^1)^T \ (\hat{x}^2)^T \ \dots \ (\hat{x}^n)^T]^T$ is the model state vector in the last sampling moment and $e(k) \in R^{n \times 1}$ is state error.

Consider the event triggering function as below

$$\Omega_l \|e^a(k)\| < \sigma_l \|\hat{x}^a(k)\|\quad (8)$$

Where, σ_l and Ω_l are positive scalars which must be determined. Based on (8), it can be obtained that the next transfer instant of the a th subsystem is determined by the following equation.

$$k_{t+1}^a = k_t^a + \min\{k > k_t^a \mid \Omega_l \|e^a(k)\| \geq \sigma_l \|\hat{x}^a(k)\|\}\quad (9)$$

3.5. Control Rule

The i th control rule of a th subsystem can be defined as follows

IF $\vartheta_1^a(k)$ is $\theta_{i_1}^a$ and \dots and $\vartheta_g^a(k)$ is $\theta_{i_g}^a$ THEN

$$u^a(k) = K_i^a \hat{x}^a(k)$$

$$\begin{aligned}
& + \sum_{b=1, b \neq a}^{n_a} K_i^{ab} \hat{x}^b(k), \quad a \in \{1, \dots, n\} \\
\hat{x}^a(k+1) & = \hat{A}_i^a \hat{x}^a(k) + \hat{B}_i^a u^a(k) + \sum_{b=1, b \neq a}^{n_a} \hat{A}_i^{ab} \hat{x}^b(k) \quad k \neq k_l \\
\hat{x}^b(k+1) & = \hat{A}_i^b \hat{x}^b(k) + \hat{B}_i^b u^b(k) + \sum_{f=1, f \neq b}^{n_b} \hat{A}_i^{bf} \hat{x}^f(k) \quad k \neq k_l \\
u^b(k) & = K_i^b \hat{x}^b(k) + \sum_{f=1, f \neq b}^{n_b} K_i^{bf} \hat{x}^f(k) \quad k \neq k_l \\
\hat{x}^b(k+1) & = \hat{A}_i^{ab} \bar{x}^b(k-\tau) + \hat{B}_i^b u^b(k) \quad k = k_l
\end{aligned} \tag{10}$$

Where $K_i^a \in R^{n \times p}$, $K_i^{ab} \in R^{n \times p}$ and $K_i^{bf} \in R^{n \times p}$ are desired control gains that make the closed loop system finite-time stable and transfer instants of the a th subsystem are determined by (9). $\hat{x}^f(k) \in R^{n \times 1}$ is the state of the neighboring subsystem f , $\hat{A}_i^{bf} \in R^{n \times n}$ is the constant known real matrix and other parameters are defined in previous sections. Data transmission delay among subsystems when an event occurs is equal to τ ($\tau = ah, \alpha = 1, 2, 3, \dots$). Therefore, (10) can be rewritten as below.

$$\begin{aligned}
u^a(k) & = \\
\sum_{i=1}^r \left[h_i^a(\vartheta(k)) \left[K_i^a \hat{x}^a(k) + \sum_{b=1, b \neq a}^{n_a} K_i^{ab} \hat{x}^b(k) \right] \right] \\
a & \in \{1, \dots, n\} \\
\hat{x}^a(k+1) & = \\
\sum_{i=1}^r \left[h_i^a(\vartheta(k)) \left[\hat{A}_i^a \hat{x}^a(k) + \hat{B}_i^a u^a(k) + \sum_{b=1, b \neq a}^{n_a} \hat{A}_i^{ab} \hat{x}^b(k) \right] \right] \quad k \neq k_l \\
\hat{x}^b(k+1) & = \\
\sum_{i=1}^r \left[h_i^a(\vartheta(k)) \left[\hat{A}_i^b \hat{x}^b(k) + \hat{B}_i^b u^b(k) + \sum_{f=1, f \neq b}^{n_b} \hat{A}_i^{bf} \hat{x}^f(k) \right] \right] \quad k \neq k_l \\
u^b(k) & = \\
\sum_{i=1}^r \left[h_i^a(\vartheta(k)) \left[K_i^b \hat{x}^b(k) + \sum_{f=1, f \neq b}^{n_b} K_i^{bf} \hat{x}^f(k) \right] \right] \quad k \neq k_l \\
\hat{x}^b(k+1) & = \\
\sum_{i=1}^r \left[h_i^a(\vartheta(k)) \left[\hat{A}_i^{ab} \bar{x}^b(k-\tau) + \hat{B}_i^b u^b(k) \right] \right] \quad k = k_l
\end{aligned} \tag{11}$$

4. FINITE-TIME CONTROL

In this section, it is assumed that the stabilizer control law stabilizes the closed loop system; then, the event triggering coefficients are designed to make the closed loop system finite-time bounded. Using control input (11) and event-triggered scheme (8), the fuzzy closed loop control of a th subsystem is shown as follows.

$$\begin{aligned}
\hat{x}^a(k+1) & = \sum_{i=1}^r \sum_{j=1}^r h_i^a h_j^a (\hat{A}_i^a + \hat{B}_i^a K_j^a) \hat{x}^a(k) \\
& + \sum_{i=1}^r \sum_{j=1}^r h_i^a h_j^a \hat{B}_i^a K_j^a e^a(k-\tau) + \sum_{i=1}^r h_i^a \hat{B}_i^a \omega(k)
\end{aligned}$$

(12)

$$\begin{aligned} \hat{z}^a(k) &= \sum_{i=1}^r \sum_{j=1}^r h_i^a h_j^a (\hat{G}_i^a + H_i^a K_j^a) \hat{x}^a(k) \\ &+ \sum_{i=1}^r \sum_{j=1}^r h_i^a h_j^a H_i^a K_j^a e^a(k - \tau) + \sum_{i=1}^r h_i^a L_i^a \omega(k) \end{aligned} \quad (13)$$

By using (11), the model-based distributed fuzzy T-S controller is obtained as follows

$$\begin{cases} u(k) = K\hat{x}(k) & k \neq k_l \\ \{\hat{x}(k+1) = \tilde{A}\hat{x}(k) + \tilde{B}u(k) & k \neq k_l \\ \hat{x}(k+1) = [\tilde{A}\tilde{x}(k - \tau) + \tilde{B}u(k)] & k = k_l \end{cases} \quad (14)$$

Where

$$K = \begin{bmatrix} K^{11} & K^{12} & \dots & K^{1n} \\ K^{21} & K^{22} & \dots & K^{2n} \\ \vdots & \vdots & \ddots & \vdots \\ K^{n1} & K^{n2} & \dots & K^n \end{bmatrix} \quad (15)$$

According to (12) – (14), overall system equations with n subsystem are as follows.

$$\begin{aligned} x(k+1) &= \sum_{i=1}^r \sum_{j=1}^r h_i h_j ((\tilde{A}_i + \Delta\tilde{A}_i) + \tilde{B}_i K_j) \hat{x}(k) \\ &+ \sum_{i=1}^r \sum_{j=1}^r h_i h_j \tilde{B}_i K_j e(k - \tau) + \sum_{i=1}^r h_i \tilde{D}_i \omega(k) \end{aligned} \quad (16)$$

$$\begin{aligned} z(k) &= \sum_{i=1}^r \sum_{j=1}^r h_i h_j (\tilde{G}_i + \tilde{H}_i K_j) \hat{x}(k) \\ &+ \sum_{i=1}^r \sum_{j=1}^r h_i h_j \tilde{H}_i K_j e(k - \tau) + \sum_{i=1}^r h_i \tilde{L}_i \omega(k) \end{aligned} \quad (17)$$

Where

$$\hat{x} = [(\hat{x}^1)^T \quad (\hat{x}^2)^T \quad \dots \quad (\hat{x}^n)^T]^T \quad (18)$$

$$e(k) = [(e^1)^T \quad (e^2)^T \quad \dots \quad (e^n)^T]^T \quad (19)$$

$$u = [(u^1)^T \quad (u^2)^T \quad \dots \quad (u^n)^T]^T \quad (20)$$

$$z = [(\hat{z}^1)^T \quad (\hat{z}^2)^T \quad \dots \quad (\hat{z}^n)^T]^T \quad (21)$$

$$\Delta\tilde{A}_i = \text{diag}\{\Delta\hat{A}^1 \quad \Delta\hat{A}^2 \quad \dots \quad \Delta\hat{A}^n\} \quad (22)$$

$$\tilde{B}_i = \text{diag}\{B^1 \quad B^2 \quad \dots \quad B^n\} \quad (23)$$

$$\tilde{D}_i = \text{diag}\{D^1 \quad D^2 \quad \dots \quad D^n\} \quad (24)$$

$$\tilde{G}_i = \text{diag}\{G^1 \quad G^2 \quad \dots \quad G^n\} \quad (25)$$

$$\tilde{H}_i = \text{diag}\{H^1 \quad H^2 \quad \dots \quad H^n\} \quad (26)$$

$$\tilde{L}_i = \text{diag}\{L^1 \quad L^2 \quad \dots \quad L^n\} \quad (27)$$

$$\tilde{A}_i = \begin{bmatrix} \hat{A}^1 & A_1 & \dots & \hat{A}^{1n} \\ \hat{A}^{21} & \hat{A}^2 & \dots & \hat{A}^{2n} \\ \vdots & \vdots & \ddots & \vdots \\ \hat{A}^{n1} & \hat{A}^{n2} & \dots & \hat{A}^n \end{bmatrix} \quad (28)$$

It is assumed that $\Delta\tilde{A}_i = EFJ$, where $\Delta\tilde{A}_i$ is the parametric uncertainty, J and E are constant positive known matrices with appropriate dimensions. F is a real-time variant unknown matrix that satisfies the condition $F^T F \leq I$.

Theorem 1: Matrices $P > 0$ and $Q > 0$ and constant numbers $\epsilon > 0$ and $\mu > 1$ are given; (16) is finite-time bounded with respect to (c_1, c_2, ϖ, N, R) if the following condition

$$(c_1 + \gamma^2 \mu^N \varpi) - c_2 < 0 \tag{29}$$

and the following LMI holds.

$$\begin{bmatrix} -P & * & * & * \\ P(\tilde{A}_i + \tilde{B}_i K_j) & -P & * & * \\ E & 0 & -\epsilon^{-1}I & * \\ J & 0 & 0 & -\epsilon I - \gamma^2 I \end{bmatrix} < 0 \tag{30}$$

in which the controllers' gain is obtained by (14).

Proof:

Consider the Lyapunov function

$$V(k) = x^T(k)Px(k) \tag{31}$$

For $k \in [k_l + \tau \ k_{l+1} + \tau)$ by calculating the forward difference and replacing parametric uncertainty $\Delta\tilde{A}_i$ by EFJ one can arrive at

$$\begin{aligned} \Delta V(k) &= V(k+1) - V(k) - \gamma^2 \omega^T(k)\omega(k) \\ &= \sum_{i=1}^r \sum_{j=1}^r h_i h_j x^T(k) \left[((\tilde{A}_i + \tilde{B}_i K_j) + EFJ)^T P + P((\tilde{A}_i + \tilde{B}_i K_j) + EFJ) - P \right] x(k) \\ &+ \sum_{i=1}^r \sum_{j=1}^r h_i h_j x^T(k) [(\tilde{A}_i + \tilde{B}_i K_j) + EFJ]^T P [\tilde{B}_i K_j] e(k - \tau) \\ &+ \sum_{i=1}^r \sum_{j=1}^r h_i h_j e^T(k - \tau) [\tilde{B}_i K_j]^T P [(\tilde{A}_i + \tilde{B}_i K_j) + EFJ] x(k) \\ &+ \sum_{i=1}^r \sum_{j=1}^r h_i h_j e^T(k - \tau) [\tilde{B}_i K_j]^T P [\tilde{B}_i K_j] e(k - \tau) \\ &+ \sum_{i=1}^r \sum_{j=1}^r h_i h_j x^T(k) [(\tilde{A}_i + \tilde{B}_i K_j) + EFJ]^T P \tilde{D}_i \omega(k) \\ &+ \sum_{i=1}^r \sum_{j=1}^r h_i h_j \omega^T(k) \tilde{D}_i^T(k) P [(\tilde{A}_i + \tilde{B}_i K_j) + EFJ] x(k) \\ &+ \sum_{i=1}^r \sum_{j=1}^r h_i h_j \omega^T(k) \tilde{D}_i^T(k) P [\tilde{B}_i K_j] e(k - \tau) + \\ &\sum_{i=1}^r \sum_{j=1}^r h_i^2 \omega^T(k) \tilde{D}_i^T P \tilde{D}_i \omega(k) - \gamma^2 \omega^T(k)\omega(k) \end{aligned} \tag{32}$$

Equation (32) can be written as follows

$$\sum_{i=1}^r \sum_{j=1}^r h_i h_j \begin{bmatrix} x^T(k) & e^T(k - \tau) & \omega^T(k) \end{bmatrix} \begin{bmatrix} Q_{11} & Q_{12} & Q_{13} \\ Q_{12}^T & Q_{22} & Q_{23} \\ Q_{13}^T & Q_{23}^T & Q_{33} \end{bmatrix} \begin{bmatrix} x(k) \\ e(k - \tau) \\ \omega(k) \end{bmatrix}$$

$$-\gamma^2 \omega^T(k) \omega(k) \tag{33}$$

Where

$$Q_{11} = \left[((\tilde{A}_i + \tilde{B}_i K_j) + EFJ)^T P + P((\tilde{A}_i + \tilde{B}_i K_j) + EFJ) - P \right] \tag{34}$$

$$Q_{22} = [\tilde{B}_i K_j]^T P [\tilde{B}_i K_j] \tag{35}$$

$$Q_{33} = \tilde{D}_i^T P \tilde{D}_i \tag{36}$$

$$Q_{12} = [(\tilde{A}_i + \tilde{B}_i K_j) + EFJ]^T P [\tilde{B}_i K_j] \tag{37}$$

$$Q_{13} = [(\tilde{A}_i + \tilde{B}_i K_j) + EFJ]^T P \tilde{D}_i \tag{38}$$

$$Q_{23} = [\tilde{B}_i K_j]^T P \tilde{D}_i \tag{39}$$

By assumption that $\begin{bmatrix} Q_{11} & Q_{12} & Q_{13} \\ Q_{12}^T & Q_{22} & Q_{23} \\ Q_{13}^T & Q_{23}^T & Q_{33} \end{bmatrix} < 0$ and since $h_i h_j(\vartheta(k)) > 0$ and $\sum_{i=1}^r h_i h_j(\vartheta(k)) = 1$, the above equations can be rewritten as follows:

$$\Delta V(k) = [x^T(k) \quad e^T(k - \tau) \quad \omega^T(k)] \begin{bmatrix} x(k) \\ e(k - \tau) \\ \omega(k) \end{bmatrix} < \gamma^2 \omega^T(k) \omega(k) \tag{40}$$

Lemma 3 has been used to check the performance of the system in the face of parametric uncertainty. Based on Lemma 3, the following inequality is correct.

$$\begin{aligned} & \left((\tilde{A}_i + \tilde{B}_i K_j) + EFJ \right)^T P \left((\tilde{A}_i + \tilde{B}_i K_j) + EFJ \right) \\ & \leq (\tilde{A}_i + \tilde{B}_i K_j)^T (P^{-1} - \epsilon E E^T)^{-1} (\tilde{A}_i + \tilde{B}_i K_j) \\ & \quad + \epsilon^{-1} J^T J + \gamma^2 \omega^T \omega \end{aligned} \tag{41}$$

According to Lemma 2, the above inequality can be written as

$$\begin{bmatrix} -P & * & * & * \\ P(\tilde{A}_i + \tilde{B}_i K_j) & -P^{-1} & * & * \\ E & 0 & -\epsilon^{-1} I & * \\ J & 0 & 0 & -\epsilon I - \gamma^2 I \end{bmatrix} < 0 \tag{42}$$

Then, pre- and post-multiplying (42) by $\text{diag}\{I, P_i, I, I\}$ and its transpose, respectively; (30) is obtained. Based on Lemma 4, it can be obtained that

$$\Delta V(k) - (\mu - 1)V(k) < 0 \tag{43}$$

that is

$$V(k) < \mu V(k - 1) \tag{44}$$

so it is concluded that

$$V(k) < \mu V(k - 1) < \mu^2 V(k - 2) < \dots < \mu^N V(0) \tag{45}$$

Therefore, for (29)

$$\begin{aligned} V(k) & \leq \mu V(k - 1) + \gamma^2 \omega^T(k - 1) \omega(k - 1) \\ & \leq \mu^2 V(k - 2) + \mu \gamma^2 \omega^T(k - 1) \omega(k - 1) + \omega^T(k - 2) \omega(k - 2) \\ & \vdots \\ & \leq \mu^N V(0) + \gamma^2 \sum_{i=0}^{N-1} \mu^{N+1-i} \omega^T(k - i) \omega(k - i) \end{aligned}$$

$$\leq \mu^N V(0) + \gamma^2 \mu^N \varpi$$

by placing $\bar{P} = R^{-1/2} P R^{-1/2}$, it can be obtained $V(0) = x^T(0) R^{-1/2} \bar{P} R^{-1/2} x(0) \leq c_1$. Based on (29), it can be found that

$$c_2 - (c_1 + \gamma^2 \mu^N \varpi) > 0 \quad (46)$$

Therefore, it can be concluded that

$$\frac{x^T(k) R x(k)}{c_1 + \gamma^2 \mu^N \varpi} < \frac{c_2}{c_1 + \gamma^2 \mu^N \varpi} \times (c_1 + \gamma^2 \mu^N \varpi) = c_2 \quad (47)$$

Based on Definition 1, (16) is finite-time bounded according to (c_1, c_2, ϖ, N, R) , and the proof is completed.

In the following, the condition of minimum time between events for the proposed controller is demonstrated. For this purpose, d_M is considered as the minimum time between events and is defined in (48).

$$0 \leq d(k) \leq h + \tau = d_M \quad (48)$$

Obviously, if there is a minimum time between executions, the number of execution times cannot be infinite. That is, Zeno's behavior can be removed.

Theorem 2: Consider the fuzzy T-S system (16) with event-triggering condition (8), then the minimum inter-event time is equal to d_M .

Proof:

It concluded that $\Delta e(k) = -\Delta x(k)$, then for $k \in [k_l + \tau, k_{l+1} + \tau)$

$$\begin{aligned} \|\Delta e(k)\| &\leq \left\| \sum_{i=1}^r \sum_{j=1}^r h_i h_j ((\tilde{A}_i + \tilde{B}_i K_j) x(k) + \sum_{i=1}^r \sum_{j=1}^r h_i h_j \tilde{B}_i K_j e(k - \tau) + \sum_{i=1}^r h_i \tilde{D}_i \omega(k) \right\| \\ &\leq \left\| \sum_{i=1}^r \sum_{j=1}^r h_i h_j \tilde{B}_i K_j - \sum_{i=1}^r \sum_{j=1}^r h_i h_j ((\tilde{A}_i + \tilde{B}_i K_j) \right\| \|e(k - \tau)\| \\ &+ \left\| \sum_{i=1}^r \sum_{j=1}^r h_i h_j (\tilde{A}_i + \tilde{B}_i K_j) + \sum_{i=1}^r \sum_{j=1}^r h_i h_j \tilde{B}_i K_j \right\| \|x(k_l)\| + \left\| \sum_{i=1}^r h_i \tilde{D}_i \right\| \|\omega(k)\| \end{aligned} \quad (49)$$

Since $h_i h_j (\vartheta(k)) > 0$ and $\sum_{i=1}^r h_i h_j (\vartheta(k)) = 1$, the above equations is written as follows:

$$\begin{aligned} \|\Delta e(k)\| &\leq \|(\tilde{A}_i + \tilde{B}_i K_j) x(k) + \tilde{B}_i K_j e(k - \tau) + \tilde{D}_i \omega(k)\| \\ &\leq \|\tilde{B}_i K_j - (\tilde{A}_i + \tilde{B}_i K_j)\| \|e(k - \tau)\| + \|(\tilde{A}_i + \tilde{B}_i K_j) + \tilde{B}_i K_j\| \|x(k_l)\| + \|\tilde{D}_i\| \|\omega(k)\| \leq v_1 \|e(k - \tau)\| + v_2 \end{aligned} \quad (50)$$

in which

$$\begin{aligned} v_1 &= \max\{\lambda((\tilde{B}_i K_j) - (\tilde{A}_i + \tilde{B}_i K_j))\} \\ v_2 &= \max\{\lambda(\tilde{A}_i + \tilde{B}_i K_j)\} \|x(k_l)\| + \max\{\lambda(\tilde{D}_i)\} \sqrt{\varpi} \end{aligned} \quad (51)$$

For $k \in [k_l + \tau, k_{l+1} + \tau)$, the following auxiliary variable is defined.

$$\|\Delta v(k)\| = v_1 \|v(k)\| + v_2 \quad (52)$$

Where $\|\Delta v(k - \tau)\| = 0$. Based on comparison lemma it can be found that $e(k - \tau) \leq v(k)$. Moreover, for $k \in [k_l + \tau, k_{l+1} + \tau)$, two modes will be obtained.

$$\begin{aligned} \text{A) } v_1 &\neq 0 \\ \|v(k)\| &= \frac{v_2}{v_1} (e^{v_1(k-k_l)} - 1) \end{aligned} \quad (53)$$

$$\begin{aligned} \text{B) } v_1 &= 0 \\ \|v(k)\| &= v_2(k - k_l) \end{aligned} \quad (54)$$

On the other hand, based on event triggering condition (8) for $k \in [k_l + \tau, k_{l+1} + \tau)$, it can be concluded that

$$\|e(k - \tau)\| \leq \frac{\sigma_l}{\Omega_l} \|x(k_l)\| \leq \frac{\sigma_l}{\Omega_l} \|x(k_l) - e(k - \tau)\| \quad (55)$$

Considering that, $\frac{\sigma_l}{\Omega_l} \cong 1$ and $\|x(k_l) - e(k - \tau)\|^2 \geq (\|x(k_l)\| - \|e(k - \tau)\|)^2$ then the sufficient condition for (55) is obtained as follows.

$$\|e(k - \tau)\|^2 \leq (\|x(k_l)\| - \|e(k - \tau)\|)^2 \quad (56)$$

If $v_1 \neq 0$, by combining (53) and (55), it can be obtained that

$$d_M = \frac{1}{v_1} \ln \left(1 + \frac{v_1}{v_2} \|x(k_l)\| \right) \quad (57)$$

If $v_1 = 0$, by combining (53) and (55), it can be obtained that

$$d_M = \frac{1}{v_2} \|x(k_l)\| \quad (58)$$

From (57) and (58), it can be concluded that $d_M > 0$. So, there is a minimum inter event time.

5. SIMULATION

In this section, the effectiveness and advantages of the developed model-based finite-time event-triggered control scheme have been checked using MATLAB software for a centralized and a distributed fuzzy T-S system, respectively.

Example 1 ([37])

A class of discrete fuzzy system is shown below.

Rule 1: IF $x_1(k)$ is M_1 THEN
 $x(k+1) = A_1x(k) + B_1u(k), z(k) = C_1x(k)$

Rule 2: IF $x_1(k)$ is M_2 THEN
 $x(k+1) = A_2x(k) + B_2u(k), z(k) = C_2x(k)$

Membership functions for rules 1 and 2 are as below.

$$M_1(x_1(x)) = \frac{1}{1 + \exp(-2x_1(k))}$$

$$M_2(x_1(x)) = 1 - M_1(x_1(x))$$

With

$$A_1 = \begin{bmatrix} -0.5 & 2 \\ -0.1 & 1.1 \end{bmatrix}, A_2 = \begin{bmatrix} -0.19 & 0.5 \\ -0.1 & -1.2 \end{bmatrix}$$

$$B_1 = \begin{bmatrix} 4.1 \\ 4.8 \end{bmatrix}, B_2 = \begin{bmatrix} 3 \\ 0.1 \end{bmatrix}$$

$$C_1 = [1 \quad 0.3], C_2 = [0.8 \quad 0.2]$$

Control rule is as below.

Rule 1: IF $x_1(k)$ is M_1 THEN $u(k) = k_1x_1(k)$

Rule 2: IF $x_1(k)$ is M_2 THEN $u(k) = k_2x_1(k)$

Initial conditions are

$$x_1(0) = 2.054, x_2(0) = -2.054$$

In Fig.3. the time between two consecutive events is shown. By choosing $\frac{\sigma_l}{\Omega_l} = 0.22$, the event-triggered system is stable. Based on (42), the value of $\frac{\sigma_l}{\Omega_l}$ is equal to 0.9. In Fig.4. event ratio (R) versus error criterion ($\frac{\sigma_l}{\Omega_l}$) from 0 to 0.22 is shown. As can be seen, with the increase in the error criterion ($\frac{\sigma_l}{\Omega_l}$), event ratio decreases.

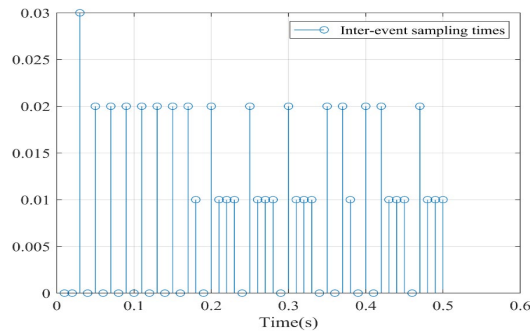

Fig. 3. The time between two consecutive events for a stable system.

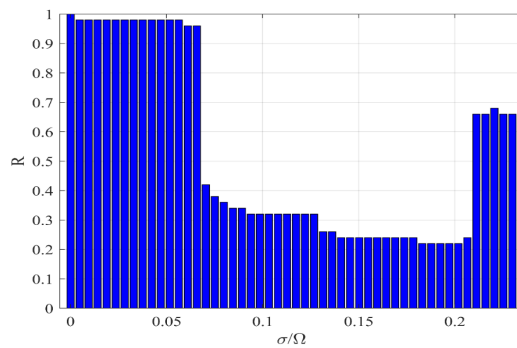

Fig. 4. Event ratio versus error criterion ($\frac{\sigma_l}{\Omega_l}$).

In Fig. 5, the history of $x(k)^T R x(k)$ for the stable system is shown. For the given initial conditions, it can be seen that

$$x(0)^T R x(0) < 8.4378 \Rightarrow x(k)^T R x(k) < 48.28$$

So, based on Definition 1, the system is finite-time bounded.

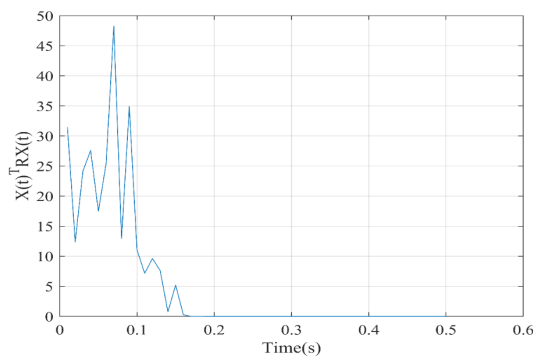

Fig. 5. History of $x(k)^T R x(k)$.

Example 2

Consider the DC-DC buck converter of a subsystem of a distributed network as in Fig. 6. It should be noted that uncertainties and disturbances are not considered.

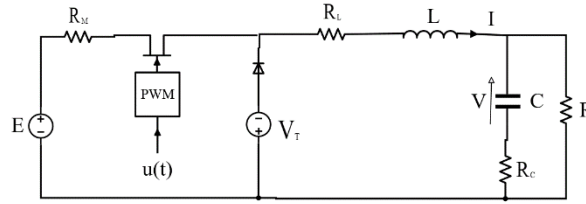

Fig. 6. DC-DC buck converter of a subsystem.

To verify the effectiveness of the proposed method, based on the distributed topology that is presented in [38-41], the distributed grid which consists of four DC-DC buck converters is simulated as in Fig. 7.

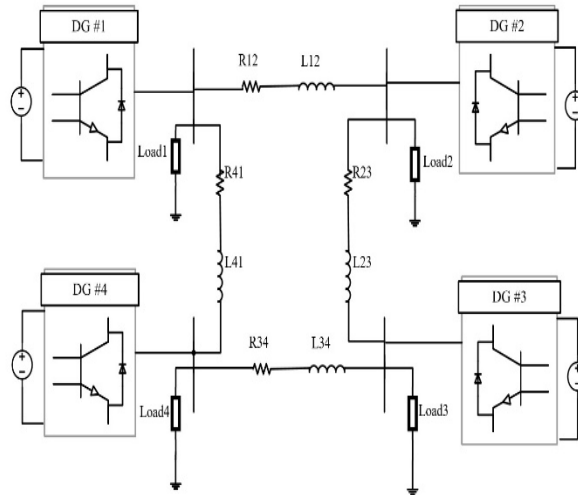

Fig. 7. Islanded DC microgrid including 4 distributed generators (DGs).

Fuzzy T-S model of DC-DC buck converter is as follows [42]

$$x(k + 1) = Ax(k) + B(x)u(k) + D \tag{59}$$

Where

$$0 \leq u(k) \leq 1, x(k) = \begin{bmatrix} i(k) \\ v(k) \end{bmatrix}$$

$$A = \begin{bmatrix} \frac{R_L R_i + R_i R_{C_i}}{L_i} & -\frac{R_i}{L_i R_i + L_i R_{C_i}} \\ \frac{R_i}{C_i R_i + C_i} & -\frac{1}{C_i R_i + C_i R_{C_i}} \end{bmatrix},$$

$$B(x) = \begin{bmatrix} -\frac{R_M i(t) - E - V_r}{L_i} \\ 0 \end{bmatrix}, D = \begin{bmatrix} -\frac{V_r}{L_i} \\ 0 \end{bmatrix}$$

Where $i = 1, \dots, 4$ is the index of DGs.

DC-DC buck converter parameters of each of the 4 DGs and parameters of DC-DC buck converter model are presented in Table 1 and Table 2, respectively. Also, the distributed network parameters are presented in Table 3.

Table 1. DC-DC Buck Converter Parameters.

Parameter	Value
R_1, R_2, R_3, R_4	6 Ω , 5.7 Ω , 6.3 Ω , 6.6 Ω
$R_{L_1}, R_{L_2}, R_{L_3}, R_{L_4}$	48.4 m Ω , 45.9 m Ω , 50.8 m Ω , 53.2 m Ω
E	30 V
L_1, L_2, L_3, L_4	98.5 mH, 93.6 mH, 103.5 mH, 108.4 mH
$R_{C_1}, R_{C_2}, R_{C_3}, R_{C_4}$	0.162 Ω , 0.153 Ω , 0.170 Ω , 0.178 Ω
$R_{M_1}, R_{M_2}, R_{M_3}, R_{M_4}$	0.27 Ω , 0.25 Ω , 0.28 Ω , 0.29 Ω
V_Y	0.82 V
C_1, C_2, C_3, C_4	202.5 μ F, 192.3 μ F, 212.6 μ F, 222.7 μ F

Table 2. Model Parameters of DC-DC Buck Converter.

Parameter	Value
$R_{m1}, R_{m2}, R_{m3}, R_{m4}$	4.5 Ω , 4.2 Ω , 4.8 Ω , 5.1 Ω
$R_{Lm1}, R_{Lm2}, R_{Lm3}, R_{Lm4}$	36.3 m Ω , 33.8 m Ω , 38.7 m Ω , 41.4 m Ω
E	30 V
$L_{m1}, L_{m2}, L_{m3}, L_{m4}$	73.8 mH, 68.9 mH, 78.8 mH, 83.7 mH
$R_{Cm1}, R_{Cm2}, R_{Cm3}, R_{Cm4}$	0.121 Ω , 0.113 Ω , 0.129 Ω , 0.137 Ω
$R_{Mm1}, R_{Mm2}, R_{Mm3}, R_{Mm4}$	0.20 Ω , 0.18 Ω , 0.21 Ω , 0.22 Ω
V_Y	0.82 V
$C_{m1}, C_{m2}, C_{m3}, C_{m4}$	151.8 μ F, 141.7 μ F, 162 μ F, 172.1 μ F

Table 3. Distributed Network Parameters.

Parameter	Value
$R_{12}, R_{23}, R_{34}, R_{41}$	0.1 Ω
$L_{12}, L_{23}, L_{34}, L_{41}$	2 μ F
$Load_1, Load_2, Load_3, Load_4$	16 Ω

To obtain the T-S fuzzy model of DC-DC buck converter, an interval with $r = 2$ rules is chosen as follows.

Rule 1: IF $i(k) = i_{min}$ THEN
 $x(k+1) = Ax(k) + h_1(k)B_1 + D$
 Rule 2: IF $i(k) = i_{max}$ THEN
 $x(k+1) = Ax(k) + h_2(k)B_2 + D$

Where

$$B_1 = \begin{bmatrix} \frac{-Rm_{i_{min}} + E + V_Y}{L} \\ 0 \end{bmatrix}, B_2 = \begin{bmatrix} \frac{-Rm_{i_{max}} + E + V_Y}{L} \\ 0 \end{bmatrix}, h_1(k) = \frac{i_{max} - i(k)}{i_{max} - i_{min}} \text{ and } h_2(k) = \frac{i(k) - i_{min}}{i_{max} - i_{min}} \text{ are membership functions.}$$

Using the parameters of Table 1, matrix $A_{2 \times 2}$ of distributed network is defined as below.

$$A = \begin{bmatrix} A_{11} & A_{12} \\ A_{21} & A_{22} \end{bmatrix} = \begin{bmatrix} -2.08 & -9.87 & -1.98 & -3.38 \\ 4808 & -801.40 & 4568 & -761.33 \\ -2.19 & -10.37 & -2.29 & -10.85 \\ 5048 & -841.47 & 5289 & -881.54 \end{bmatrix}$$

Using the parameters of Table 2, the initial matrix $A_{m_2 \times 2}$ of the distributed network is defined as below. When the information transmission happens, the matrix $A_{m_2 \times 2}$ is updated by receiving the states of the neighboring subsystems.

$$A_m = \begin{bmatrix} A_{m11} & A_{m12} \\ A_{m21} & A_{m22} \end{bmatrix} = \begin{bmatrix} -1.46 & -6.91 & -1.65 & -7.40 \\ 3365 & -560.98 & 3606 & -601.05 \\ -1.66 & -7.90 & -1.77 & -10.85 \\ 3846 & -641.12 & 4087 & -681.19 \end{bmatrix}$$

Event triggering function is defined based on (8). State feedback control is defined as below.

$$u = K_m v(k) + v_{ref} \quad (60)$$

State feedback gains are calculated in such a way that the closed-loop poles of the subsystems are placed at -20.77 and -806.32. It should be noted that the optimal location of closed-loop poles is based on [43]. So, the state feedback gains are calculated as below.

$$K_m = \begin{bmatrix} K_{m1} & K_{m3} \\ K_{m2} & K_{m4} \end{bmatrix} = \begin{bmatrix} 0.15 & 0.09 & 0.14 & 0.09 \\ 0.14 & 0.09 & 0.13 & 0.09 \end{bmatrix}$$

The voltage and current response, event-triggered instants, and the control input of the closed loop distributed smart grid by using Fuzzy Model-Based Event-Triggered Control (FMBETC) and Fuzzy Time-Based Event-Triggered Control (FTBETC) which is proposed in [32] for subsystems 1 to 4 are shown in Figs. 8-11. As can be seen by using FMBETC, the four subsystems are able to track the reference input but FTBETC failed to track the reference input while fewer events are triggered in FMBETC than in FTBETC.

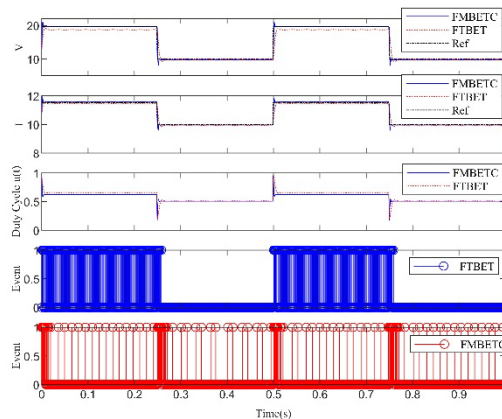

Fig. 8. Performance evaluation of DG 1 within microgrid.

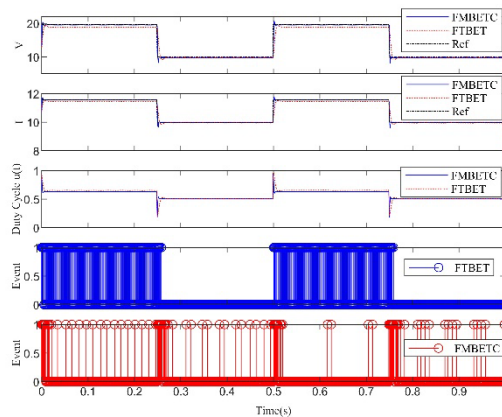

Fig. 9. Performance evaluation of DG 2 within microgrid.

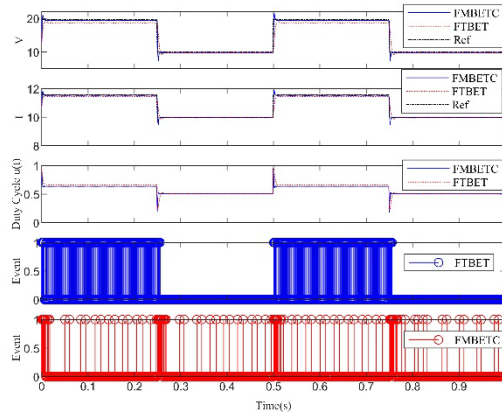

Fig. 10. Performance evaluation of DG 3 within microgrid.

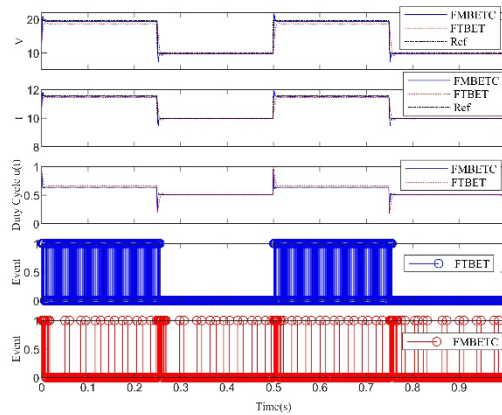

Fig. 11. Performance evaluation of DG 4 within microgrid.

One of the advantages of the model-based event-triggered scheme is to increase the network bandwidth by reducing the sent samples on the network. The ratio of the sent samples to the total number of measured samples is called the event ratio. In Table 4 event ratio of each subsystem is compared.

Table 4. The event ratio of each subsystem obtained by FMBETC and FTBETC.

	Subsystem 1	Subsystem 2	Subsystem 3	Subsystem 4
FMBETC	0.117	0.105	0.110	0.103
FTBETC [32]	0.266	0.266	0.264	0.268

In Fig. 12. the event ratio (R) versus the error criterion ($\frac{\sigma_l}{\Omega_l}$) is shown. As can be seen, with the increase of the error criterion ($\frac{\sigma_l}{\Omega_l}$), event ratio decreases.

In Fig. 13. the history of $x(k)^T R x(k)$ for a stable system is shown. For equal initial conditions for subsystems 1 to 4 respectively, it can be observed that

$$\begin{aligned}
 x_1(0)^T R x_1(0) < 3.2402 &\Rightarrow x_1(k)^T R x_1(k) < 19.17 \\
 x_2(0)^T R x_2(0) < 3.2402 &\Rightarrow x_2(k)^T R x_2(k) < 13.60 \\
 x_3(0)^T R x_3(0) < 3.2402 &\Rightarrow x_3(k)^T R x_3(k) < 9.43 \\
 x_4(0)^T R x_4(0) < 3.2402 &\Rightarrow x_4(k)^T R x_4(k) < 6.52
 \end{aligned}$$

The above inequalities satisfy Definition 2. Also, the closed-loop system satisfies LMI (30) as the following equation. So, according to Theorem 2, the closed loop system is finite-time bounded.

$$\begin{bmatrix} -4 & 0 & 0 & 0 & 43 & 4853 & 43 & 5093 \\ 0 & -4 & 0 & 0 & 17 & -774 & 17 & -814 \\ 0 & 0 & -4 & 0 & 40 & 4610 & 40 & 5331 \\ 0 & 0 & 0 & -4 & 24 & -733 & 16 & -854 \\ 43 & 17 & 40 & 24 & -4 & 0 & 0 & 0 \\ 4853 & -774 & 4610 & -733 & 0 & -4 & 0 & 0 \\ 43 & 17 & 40 & 16 & 0 & 0 & -4 & 0 \\ 5093 & -814 & 5331 & -854 & 0 & 0 & 0 & -4 \end{bmatrix} < 0$$

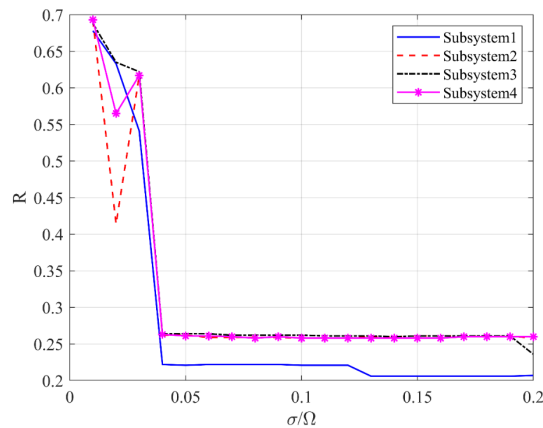

Fig. 12. Event ratio (R) versus error criterion ($\frac{\sigma_t}{\Omega_t}$).

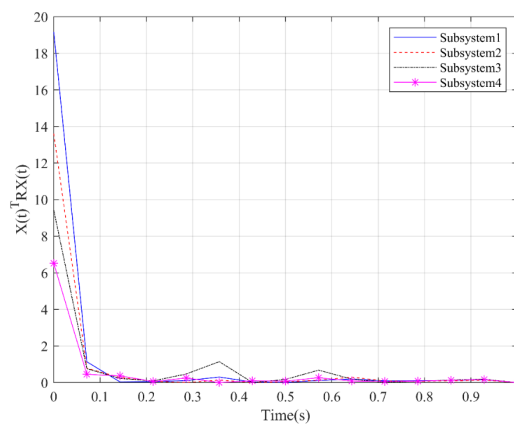

Fig. 13. History of $x(k)^T R x(k)$.

6. CONCLUSION

In this paper, model-based finite-time bounded event-triggered control for distributed fuzzy T-S systems is presented. For this purpose, the whole network model is embedded locally in both the controller and the remote telemetry unit. In the time interval between two consecutive events, the fuzzy model of the entire network is used in the controller to estimate the states of the plant. The model-based state estimation leads to the reduction of the state error and as a result, the instants of data transmission are reduced. By the model of the entire network and the event triggering block placed locally in each remote telemetry unit, the time of data transmission on the distributed network is determined. Finally, the finite-time boundedness of the closed-loop system has been investigated for a centralized system and a distributed system, respectively.

Data Availability. Data underlying the results presented in this paper are available from the corresponding author

upon reasonable request.

Funding. There is no funding for this work.

Conflicts of interest. The authors declare no conflict of interest.

Ethics. The authors declare that the present research work has fulfilled all relevant ethical guidelines required by COPE.



This article is licensed under a Creative Commons Attribution 4.0 International License.

©The Author(s) 2024

REFERENCES

- [1] S. Zhang, H. Wang, Y. Tian, “A T-S fuzzy state observer-based model predictive reset control for a class of fuzzy nonlinear systems with event-triggered mechanism,” *Journal of the Franklin Institute*, Vol. 359, No. 15, pp. 7818-7846, 2022.
- [2] Y. Jia, G. Ran, Y. Gong, L. Wang, F. Xu, “Dynamic Feedback Tracking Control for Interval Type-2 T-S Fuzzy Nonlinear System Based on Adaptive EventTriggered Strategy,” *Neural Processing Letters*, Vol. 55, pp. 1715-1740, 2023.
- [3] Y. Gu, M. Huangfu, “Event-triggered fault detection for T-S fuzzy systems with local nonlinear models in finite-frequency domain,” *Journal of Control and Decision*, Vol. 10, No. 2, pp. 250-259, 2022.
- [4] S. Abd-Elhaleem, M. Soliman. M. Hamdy, “Periodic event-triggered modified repetitive control with equivalent-input-disturbance estimator based on T-S fuzzy model for nonlinear systems,” *Soft Computing*, Vol. 26, pp. 6443-6459, 2022.
- [5] M. Li, S. Li, C. K. Ahn, Z. Xiang “Adaptive Fuzzy Event-Triggered Command-Filtered Control for Nonlinear Time-Delay Systems,” *IEEE Transactions on Fuzzy Systems*, Vol. 30, No. 4, pp. 1025-1035, 2022.
- [6] M. Fayezi; F. Bendary, M. El-hadidy, M. Mandor, “Alleviation of the Oscillation Behavior in Kundur Benchmark via Fuzzy Based Resistive Braking Scheme Considering Time Latencies and Declined Inertia,” *Majlesi Journal of electrical Engineering*, Vol. 15, No. 4, pp. 27-41, 2021.
- [7] M. Karimi; R. Sadeghi, “Improvement of Sybil Attack Detection in Vehicular Ad-Hoc Networks Using Cross-layer and Fuzzy Logic,” *Majlesi Journal of electrical Engineering*, Vol. 15, No. 1, pp. 9-18, 2021.
- [8] A. H. Zaeri, A. Esmailian-Marnani, S. Mohd Noor, “Sliding Mode Control Improvement by using Model Predictive, Fuzzy Logic, and Integral Augmented Techniques for a Quadrotor Helicopter Model,” *Majlesi Journal of electrical Engineering*, Vol. 13, No. 4, pp. 25-37, 2019.
- [9] A. Mutia, D. Abdullah, K. Kraugusteeliana, S. A. Pramono, H. Sama, “Simulation of Solar Panel Maximum Power Point Tracking Using the Fuzzy Logic Control Method,” *Majlesi Journal of electrical Engineering*, Vol. 17, No. 2, pp. 29-39, 2023.
- [10] M. A. Khaniki, M. Hadi, M. Manthouri, “Tuning of Novel Fractional Order Fuzzy PID Controller for Automatic Voltage Regulator using Grasshopper Optimization Algorithm,” *Majlesi Journal of electrical Engineering*, Vol. 15, No. 2, pp. 39-45, 2021.
- [11] G. Nagamani, C. Karthik, Young Hoon Joo, “Eventtriggered observer-based sliding mode control for T-S fuzzy systems via improved relaxed-based integral inequality,” *Journal of the Franklin Institute*, vVol. 357, No. 14, pp. 9543-9567, 2020.
- [12] Qing Lu, Peng Shi, Ligang Wu, Huiyan Zhang, “Eventtriggered interval Type-2 T-S fuzzy control for nonlinear networked systems,” *Journal of the Franklin Institute*, Vol. 357, No. 14, pp. 9834-9852, 2020.
- [13] G. Nagamani, Young Hoon Joo, G. Soundararajan, Reza Mohajerpoor, “Robust event-triggered reliable control for T-S fuzzy uncertain systems via weighted based inequality,” *Information Sciences*, Vol. 512, pp. 31-49, 2020.
- [14] Di Zhang, Baozhu Du, “Event-triggered controller design for positive T-S fuzzy systems with random time-delay,” *Journal of the Franklin Institute*, Vol. 359, No. 15, pp. 7796-7817, 2022.
- [15] T. Yu, Y. Liu, J. Cao, F. E. Alsaadi. “Finite-Time Stability of Dynamical System Under EventTriggered Hybrid Control. Appl Math Model,” *Applied Mathematical Modelling*, Vol. 117, pp. 286–295, 2023.
- [16] Y. Li, Y-X Li, S. Tong, “Event-Based Finite-Time Control for Nonlinear Multi-Agent Systems with Asymptotic Tracking,” *IEEE Transactions on Automatic Control*, to be published.
- [17] W. Song, X. Li, S. Tong. “Finite-Time EventTriggered Output Feedback H_∞ Control for Nonlinear Systems via Interval Type-2 TakagiSugeno Fuzzy Systems,” *Information Sciences*, Vol. 592, pp. 67–81, 2022.
- [18] W. Qi, Y. Hou, G. Zong and C. K. Ahn, “Finite-Time Event-Triggered Control for Semi-Markovian Switching Cyber-Physical Systems with FDI Attacks and Applications,” *IEEE Transactions on Circuits and Systems I: Regular Papers*, Vol. 68, No. 6, pp. 2665- 2674, 2021.
- [19] K. Sun, J. Qiu, H. R. Karimi and Y. Fu, “EventTriggered Robust Fuzzy Adaptive Finite-Time Control of Nonlinear Systems with Prescribed Performance,” *IEEE Transactions on Fuzzy Systems*, Vol. 29, No. 6, pp. 1460-1471, 2021.

- [20] P. Du, Y. Pan, H. Li and H. -K. Lam, “Nonsingular Finite-Time Event-Triggered Fuzzy Control for Large-Scale Nonlinear Systems,” *IEEE Transactions on Fuzzy Systems*, Vol. 29, No. 8, pp. 2088-2099, 2021.
- [21] Z. Fei, S. Shi, C. Ki Ahn, M. V. Basin, “Finite-Time Control for Switched T-S Fuzzy Systems via a Dynamic Event-Triggered Mechanism,” *IEEE Transactions on Fuzzy Systems*, Vol. 29, No. 12, pp. 3899-3909, 2021.
- [22] J. Song, D. W. C. Ho and Y. Niu, “Model-Based Event-Triggered Sliding-Mode Control for Multi-Input Systems: Performance Analysis and Optimization,” *IEEE Transactions on Cybernetics*, Vol. 52, No. 5, pp. 3902-3913, 2022.
- [23] H. Zhou, S. Sui, S. Tong, “Fuzzy Adaptive Finite-Time Consensus Control for High-Order Nonlinear Multiagent Systems Based on Event-Triggered,” *IEEE Transactions on Fuzzy Systems*, Vol. 30, No. 11, pp. 4891-4904, 2022.
- [24] W. Qi, C. Zhang, G. Zong, S. -F. Su, M. Chadli, “Finite-Time Event-Triggered Stabilization for Discrete-Time Fuzzy Markov Jump Singularly Perturbed Systems,” *IEEE Transactions on Cybernetics*, Vol. 53, No. 7, pp. 4511-4520, 2023.
- [25] J. Wang, Y. Yan, C. Ma, Z. Liu, K. Ma, C.L.P. Chen, “Fuzzy adaptive event-triggered finite-time constraint control for output-feedback uncertain nonlinear systems,” *Fuzzy Sets and Systems*, Vol. 443, pp. 236-257, 2022.
- [26] R. Kavikumar, O. -M. Kwon, S. -H. Lee, S. Lee, R. Sakthivel, “Event-Triggered Input-Output Finite-Time Stabilization for IT2 Fuzzy Systems Under Deception Attacks,” *IEEE Transactions on Fuzzy Systems*, Vol. 31, No. 4, pp. 1139-1151, 2023.
- [27] Z. Song, P. Li, Z. Sun, Z. Wang, “Finite-Time Adaptive Fuzzy Event-Triggered Control of Constrained Nonlinear Systems via Bounded Command Filter,” *IEEE Transactions on Fuzzy Systems*, Vol. 31, No. 1, pp. 117-128, 2023.
- [28] L. Zhang, W. -W. Che, C. Deng, Z. -G. Wu, “Prescribed Performance Control for Multiagent Systems via Fuzzy Adaptive Event-Triggered Strategy,” *IEEE Transactions on Fuzzy Systems*, Vol. 30, No. 12, pp. 5078-5090, 2022.
- [29] S. Liu, W. Luo and L. Wu, “Co-Design of Distributed Model-Based Control and Event-Triggering Scheme for Load Frequency Regulation in Smart Grids,” *IEEE Transactions on Systems, Man, and Cybernetics: Systems*, Vol. 50, No. 9, pp. 3311-3319, 2020.
- [30] X. Li, W. Song, Y. Li and S. Tong, “Finite-Time Dynamic Event-Triggered Fuzzy Output Fault-Tolerant Control for Interval Type-2 Fuzzy Systems,” *IEEE Transactions on Fuzzy Systems*, Vol. 30, No. 11, pp. 4926-4938, 2022.
- [31] W. Song, X. Li, S. Tong, “Finite-time event-triggered output feedback H_∞ control for nonlinear systems via interval type-2 Takagi-Sugeno fuzzy systems,” *IEEE Information Sciences*, Vol. 592, pp. 67-81, 2022.
- [32] P. Mani, Y. Hoon Joo, “Fuzzy Event-triggered Control for Back to Back Converter involved PMSG-based Wind Turbine Systems,” *IEEE Transactions on Fuzzy Systems*, Vol. 30, No. 5, pp. 1409-1420, 2022.
- [33] S. Boyd, L. El Ghaoui, E. Feron, V. Balakrishnan, “Linear Matrix Inequalities in System and Control Theory,” *SIAM Philadelphia PA*, 1994.
- [34] W. Youyi Wang, L. Xie, C. E. de Souza, “Robust Control of a Class of Uncertain Nonlinear Systems,” *Systems & Control Letters*, Vol. 19, pp.139-149, 1992.
- [35] Z. Wang, F. Yang, D. W. C. Ho, X. Li, “Robust H_∞ Control for Networked Systems with Random Packet Losses,” *IEEE Transactions on Systems, Man, and Cybernetics: Systems*, Vol. 37, No. 4, pp. 916-924, 2007.
- [36] X. Li, X. Lin, S. Li, Y. Zou, “Finite-Time Stability of Switched Linear Systems with Subsystems Which are not Finite-Time Stable,” *IET Control Theory & Application*, Vol. 8, No. 12, pp. 1137-1146, 2014.
- [37] Y. Xia, H. Yang, P. Shi, M. Fu, “Constrained Infinite-Horizon Model Predictive Control for Fuzzy Discrete-Time Systems,” *IEEE Transactions on Fuzzy Systems*, Vol. 18, No. 2, pp. 429-436, 2010. 13
- [38] N. M. Dehkordi, N. Sadati, M. Hamzeh, “Distributed Robust Finite-Time Secondary Voltage and Frequency Control of Islanded Microgrids,” *IEEE Transactions on Power Systems*, Vol. 32, No. 5, pp. 3648-3659, 2017.
- [39] H. Amiri, G.R. Arab Markadeh, N. Mahdian Dehkordi, F. Blaabjerg, “fully decentralized robust backstepping voltage control of photovoltaic systems for DC islanded microgrids based on disturbance observer method,” *ISA Transactions*, Vol. 101, pp. 471-481. 2020.
- [40] H. Habib Amiri, Gholamreza Arab Markadeh, Nima Mahdian Dehkordi, “Voltage control in a DC islanded microgrid based on nonlinear disturbance observer with CPLs,” *Journal of Energy Storage*, Vol. 29, 2020.
- [41] M. Zellagui, A. Youssef Abdelaziz, “Optimal Coordination of Directional Overcurrent Relays using Hybrid PSO-DE Algorithm,” *International Electrical Engineering Journal*, Vol. 6, No. 4, pp. 1841-1849, 2015.
- [42] Y. Li, Z. Ji, “T-S Modeling, Simulation and Control of the Buck Converter,” *2008 Fifth International Conference on Fuzzy Systems and Knowledge Discovery*.
- [43] A. Benzaouia, F. Mesquine, M. Benhayoun, H. Schulte, S. Georg, “Stabilization of Positive Constrained T-S Fuzzy Systems: Application to a Buck Converter,” *Journal of the Franklin Institute*, Vol. 351, No. 8, pp. 4111-4123, 2014.